

The Crabtree logo features a stylized green wave symbol to the left of the brand name "Crabtree" in a bold, green, sans-serif font.

Control Equipment

# Crabtree



Acknowledged as one of Britain's leading manufacturers of circuit protection equipment and wiring accessories. Crabtree's product range is renowned for its outstanding quality and excellent value for money. Specified worldwide, Crabtree products are designed to satisfy the needs of contractors, wholesalers and end-users in industrial, commercial and domestic markets alike.



Every Crabtree product is rigorously tested before being dispatched to the customer. This excellence is reinforced by the company's registration of compliance with ISO 9002: 1994 which ensures that these procedures are maintained at the highest level.

Crabtree's product ranges are developed with flexibility in mind, and with the evolution of more modular ranges, customers can be confident of obtaining the right product for each application.

The same attention to detail can be seen in the company's commitment to customer service. With up-to-the minute technology at the heart of its management information systems, the company is able to manufacture and despatch in the shortest possible time, whilst a communications network in it's Central Sales Office ensures that customer enquiries are dealt with speedily and effectively.

The company's commitment does not end there. Specifying Crabtree products ensures not only a first class product, but also the benefit of a wide range of support services. For example, comprehensive product and technical literature, a highly qualified sales force and extensive wholesaler training. Crabtree's Technical Services Department is able to offer expert advice on technical issues, and the preparation of individual quotes.



All Crabtree products comply with the applicable British Standard specification and should be installed by suitably qualified personnel in accordance with the requirements of relevant legislation, regulations (including IEE Wiring Regulations) and the accepted practice in the industry. For ease of product selection, the catalogue is divided into sections. Each has its own

introduction and contains relevant product information. It is the practice of the Electrium Group of companies to protect new ideas by seeking patent protection, and to protect new designs by seeking registered design protection, and the products listed or described in this publication may in consequence be protected by one or more patents, and/or registered designs and/or applications.

A full list of patents, registered designs and applications may be obtained from the Company Secretary of Electrium Limited.



<b>CEICON</b> STARTER SELECTION GUIDE	<b>2</b>
<b>CEICON</b> ENCLOSED HEATING AND LIGHTING CONTACTOR SELECTION	<b>6</b>
<b>CEICON</b> OPEN CONTACTORS, STARTERS, OVERLOAD RELAYS AND ACCESSORIES	<b>7</b>
<b>MANUAL MOTOR STARTERS</b> COMPACT MOTOR CONTROL COMPONENTS	<b>12</b>
<b>SILENT OPERATION</b> <b>INSTALLATION CONTACTORS</b> MODULAR DIN RAIL CONTACTORS	<b>14</b>
<b>R22</b> ASSEMBLED PUSHBUTTON STARTERS	<b>16</b>
<b>R22</b> 22.5mm CONTROL COMPONENTS	<b>19</b>
<b>MCS</b> ENCLOSED AND OPEN MOTOR CIRCUIT SWITCHES	<b>22</b>
<b>POSITION SWITCHES</b> STANDARD AND POSITIVE OPENING	<b>24</b>
<b>TECHNICAL DATA</b> SPECIFICATIONS AND DIMENSIONS	<b>26</b>

Please Note: For assistance with project enquires and quotations, please contact Electrium on the following telephone number: 01543 455200

## CEICON CONTACTORS & STARTERS

New Ceicon remains the heart of Crabtree's control equipment range, with a comprehensive selection of mini and standard contactors, overload relays, enclosures and accessories. New improvements such as three terminal coils, new overload relays, and accessories signal ongoing commitment to the development of Ceicon.

Available in component form to mix and match, Ceicon is suitable for either panel builders or the creation of individual enclosed starters.



## DIRECT-ON-LINE STARTERS up to 63A

- For example DOL starter, motor rating 4kW at 400/415V 3ph, contactor with 230/240V coil, enclosure with start/stop buttons & integral motor circuit switch: overload relay **55500/MC**, contactor **53400/ZB**, enclosure **55011/AA0**.

- Locate the kW, HP or Full Load Current of the motor and select the overload relay.
- Choose the contactor with the appropriate coil voltage (alternative coils see page 11).
- Choose the enclosure with the required pushbuttons (with or without MCS).



Overload relay				Direct-on contactor		Enclosure		
Approx motor rating at 400/415V 3ph		Full load current (A)	LIST No	Coil voltage 50Hz	LIST No	Pushbutton arrangement	LIST No	
kW	HP	min-max						
0.06	0.08	0.15-0.25	55500/BC	C10 24V 110V 230V 400V	53400/ZP 53400/ZM 53400/ZB 53400/ZJ	Start & Stop None Reset only	55001/AA0* 57001/AA1 57001/AA2	
0.12	0.16	0.24-0.4	55500/CC					
0.18	0.25	0.38-0.63	55500/DC					
0.25	0.33	0.6-1	55500/FC					
0.55	0.75	0.96-1.6	55500/GC					
1.1	1.5	1.5-2.5	55500/HC					
1.5	2	2.4-4	55500/JC					
2.2	3	3.8-6.3	55500/KC					
4	5.5	6-10	55500/MC					
4	5.5	6-10	55500/MC					C14 110V 230V 400V
5.5	7.5	6-10	55500/MC					
7.5	10	9.6-16	55500/NC	C19 110V 230V 400V	55400/ZM 55400/ZB 55400/ZJ			
11	15	15-25	57500/PC	C22 110V 230V 400V	56400/ZM 56400/ZB 56400/ZJ	Start & Stop None Reset only	57001/AA0* 57001/AA1 57001/AA2	
15	20	24-40	57500/QC	C30 110V 230V 400V	57400/ZM 57400/ZB 57400/ZJ	Start & Stop None Reset only	57011/AA0* 57011/AA1 57011/AA2	with Motor Circuit Switch
11	15	13-21	49500/AD	C43 110V 230V 400V	48400/XM 48400/XB 48400/XJ	Start & Stop None Reset only	49001/AA0* 49001/AA1 49001/AA2	
12.5	17	16-25	49500/BD					
15	20	21-32	49500/CD					
22	30	25-40	49500/DD					
25	34	32-50	49500/ED	C63 110V 230V 400V	49400/XM 49400/XB 49400/XJ	Start & Stop None Reset only	49011/AC0* 49011/AC1 49011/AC2	with Motor Circuit Switch
30	40	50-63	49500/FD					

Enclosures: IP66, Steel back box with Polycarbonate front.

\* Start Switch 40600/XA included

Dimensions – see pages 32–33 Specification – see pages 27–28 Alternative coils see page 11

Wiring diagrams – see page 29

**REVERSING STARTERS up to 63A**

• For example reversing direct-on starter, motor rating 4kW at 400/415V 3ph, contactor with 415V coil, enclosure with 3 push buttons & integral motor circuit switch: overload relay **55500/MC**, contactor **53200/OJ**, enclosure **55011/AC0**.

- 1 Locate the kW, HP or Full Load Current of the motor and select the overload relay.
- 2 Choose the contactor with the appropriate coil voltage (alternative coils see page 11).
- 3 Choose the enclosure with the required pushbuttons (with or without MCS).



Overload relay				Reversing contactor		Enclosure		
Approx motor rating at 400/415V 3ph		Full load current (A) min-max	LIST No	Coil voltage 50Hz	LIST No	Push-button arrangement	LIST No	
kW	HP							
0.06	0.08	0.15-0.25	<b>55500/BC</b>	<b>C10</b> 24V 110V 230V 400V	<b>53200/OP</b> <b>53200/OM</b> <b>53200/OB</b> <b>53200/OJ</b>	I, II & 0 None Reset only	<b>55001/AB0</b> <b>57001/AB1</b> <b>57001/AB2</b>	
0.12	0.16	0.24-0.4	<b>55500/CC</b>					
0.18	0.25	0.38-0.63	<b>55500/DC</b>					
0.25	0.33	0.6-1	<b>55500/FC</b>					
0.55	0.75	0.96-1.6	<b>55500/GC</b>					
1.1	1.5	1.5-2.5	<b>55500/HC</b>					
1.5	2	2.4-4	<b>55500/JC</b>					
2.2	3	3.8-6.3	<b>55500/KC</b>					
4	5.5	6-10	<b>55500/MC</b>					
4	5.5	6-10	<b>55500/MC</b>					<b>C14</b> 110V 230V 400V
5.5	7.5	6-10	<b>55500/MC</b>					
7.5	10	9.6-16	<b>55500/NC</b>	<b>C19</b> 110V 230V 400V	<b>55200/OM</b> <b>55200/OB</b> <b>55200/OJ</b>	I, II & 0 None Reset only	<b>57001/AB0</b> <b>57001/AB1</b> <b>57001/AB2</b>	
11	15	15-25	<b>57500/PC</b>					
15	20	24-40	<b>57500/QC</b>					
11	15	13-21	<b>49500/AD</b>	<b>C43</b> 110V 230V 400V	<b>48200/OM</b> <b>48200/OB</b> <b>48200/OJ</b>	I, II & 0 None Reset only	<b>49001/AB0</b> <b>49001/AC1</b> <b>49001/AC2</b>	
12.5	17	16-25	<b>49500/BD</b>					
15	20	21-32	<b>49500/CD</b>					
22	30	25-40	<b>49500/DD</b>					
25	34	32-50	<b>49500/ED</b>	<b>C63</b> 110V 230V 400V	<b>49200/OM</b> <b>49200/OB</b> <b>49200/OJ</b>	I, II & 0 None Reset only	<b>49011/AD0</b> <b>49011/AE1</b> <b>49011/AE2</b>	with Motor Circuit Switch
30	40	50-63	<b>49500/FD</b>					

Enclosures: I, II & 0 versions supplied with separate legends FOR/REV, UP/DOWN, OPEN/CLOSE

C10 - C30 are IP66, comprising Steel back box and Polycarbonate cover. C43/C63 versions comprise IP55 Steel cabinet and hinged gasketed door.

Dimensions - see pages 32-33 Specification - see pages 27-28 Alternative coils - see page 11

Wiring diagrams - see page 30

## STAR-DELTA STARTERS up to 109A

• For example star-delta starter, motor rating 7.5kW at 400/415V AC3, contactor with 400/415V coil, enclosure with start/stop push buttons & integral motor circuit switch: overload relay **55500/MC**, star-delta contactor **55300/OJ**, enclosure **55011/AD0**.

**1** Locate the kW, HP or Full Load Current of the motor and select the overload relay.

**2** Choose the contactor with the appropriate coil voltage (alternative coils see page 11).

**3** Choose the enclosure with the required pushbuttons (with or without MCS).



Overload relay				Star-delta contactor		Enclosure	
Approx motor rating at 400/415V 3ph		Full load current (A) min-max	LIST No	Coil voltage 50Hz	LIST No	Push-button arrangement	LIST No
kW	HP						
2.2	3	4.1-6.9	55500/JC	<b>C19</b> 110V 230V 400V	55300/0M 55300/0B 55300/0J	Start & Stop None Reset only	55001/AC0
4	5.5	6.5-10.9	55500/KC				57001/AC1
7.5	10	10.3-17.2	55500/MC				57001/AC2
11	15	16.5-27.6	55500/NC				Start & Stop None Reset only
				57011/AD1			
				57011/AD2			
<i>with Motor Circuit Switch</i>							
18.5	25	25.9-43.3	57500/PC	<b>C22</b> 110V 230V 400V	56300/0M 56300/0B 56300/0J	Start & Stop None Reset only	57001/AC0
							57001/AC1
							57001/AC2
22	30	25.8-43.1	57500/PC	<b>C30</b> 110V 230V 400V	57300/0M 57300/0B 57300/0J	Start & Stop None Reset only	57011/AD0
25	34	41.5-69	57500/QC				57011/AD1
							57011/AD2
<i>with Motor Circuit Switch</i>							
18.5	25	23-36	49500/AD	<b>C43</b> 110V 230V 400V	48300/0M 48300/0B 48300/0J	Start & Stop None Reset only	49001/AC0
22	30	28-43	49500/BD				49001/AC1
30	40	37-55	49500/CD				49001/AC2
37	50	44-69	49500/DD	<b>C63</b> 110V 230V 400V	49300/0M 49300/0B 49300/0J	Start & Stop None Reset only	49011/AE0
45	60	56-87	49500/ED				49011/AE1
55	75	87-109	49500/FD				49011/AE2
<i>with Motor Circuit Switch</i>							

### STAR-DELTA APPLICATION

For Star-delta units, the overload relay is connected in the delta loop and carries the motor winding current only in the delta mode.

For ease of selection the ratings shown in the table are the equivalent motor (nameplate) currents.

The overload relay scale is calibrated for direct-on line use and therefore its scale must be set to 0.58 times rated motor (nameplate) current.

Star-Delta units are fitted with an electronic timing relay with a minimum adjustment range from 3 to 45 seconds.

Timers have an additional built-in delay period between the 'star' contactor opening and the 'delta' contactor closing.

Enclosures: C19-C30 are IP66, comprising Steel back box and Polycarbonate cover. C43/C63 are IP55 comprising Steel cabinet and hinged gasketed door.

Dimensions – see pages 32-33 Specification – see pages 27-28 Alternative coils/timers – see page 11

Wiring diagrams – see page 31

## HEATING & LIGHTING CONTACTORS up to 85A

- For example TP & N enclosed contactor with switch disconnecter to control 85A heating load (AC1 duty): contactor **49400/XB**, enclosure **49011/AA1**,  
If additional space is required in the enclosure for control modules etc, select enclosure **49011/AE1**.

- 1 Check rating required and select contactor.
- 2 Choose enclosure with or without MCS for one contactor or two (or one with space for Control Module).



Contactor			Enclosure	
AMPS PER POLE				
Heating and general mixed loads. Slightly Inductive AC1 duty (A)	Mixed Load (A)	LIST No. (230/240V) 50Hz Coil	For one contactor with or without Switch disconnecter LIST No.	For two contactors (or one with space for control module) with or without Switch disconnecter LIST No.
25	15	Type C19 55400/ZB	57001/AA1 57011/AA1 } with Switch disconnecter	57001/AB1 57011/AC1 } with Switch disconnecter
35	20	Type C30 57400/ZB		
75	45	Type C43 48400/XB	49001/AA1 49011/AC1 } with Switch disconnecter	49001/AC1* 49011/AE1* } with Switch disconnecter
85	55	Type C63 49400/XB		

## ACCESSORIES



**Paralleling links** available for single pole switching for the following contactors (2 sets required per contactor):

Contactor type	Current carrying capacity Amps (AC1 duty)	Maximum cable size	LIST No.
C30	60	16mm <sup>2</sup>	<b>56000/ZK</b>
C43/C63	120	50mm <sup>2</sup>	<b>49000/ZK</b>

**Neutral terminal** Space is provided for a proprietary neutral terminal.

Enclosures: IP66, comprising Steel back box and Polycarbonate cover. Except \* which comprise IP55 Steel cabinet and hinged gasketed door.

Dimensions – see pages 32–33 Specification – see pages 27–28 Alternative coils – see page 11

**C3/C7 TRIPLE POLE MINI CONTACTORS**

TYPE	RATING PER POLE (A)			AUXILIARY POLES		LIST No
	AC1 non inductive	AC3 inductive	Approx motor kW rating at 400/415V 3Ph	N/O	N/C	
<b>AC COIL OPERATED</b>						
C3	20	5	2.2	1	–	41400/Z_
				–	1	41400/Y_
C7	20	8.5	4	1	–	42400/Z_
				–	1	42400/Y_



41400/ZB



42400/YB

**C3/C7 MINI CONTROL RELAYS**

4A 400/415V AC15 6A 230V AC15

TYPE	CONTACTS		LIST No
	Normally open	Normally closed	
<b>AC COIL OPERATED</b>			
C3	4	–	41600/A_
	2	2	41600/B_
	3	1	41600/C_
C7	4	–	42600/A_
	2	2	42600/B_
	3	1	42600/C_



42600/AB

**Coil selection**

Complete the List No. of the control relay or contactor selected by adding the appropriate coil code letter.  
 Preferred ac coils are **P** – 24V 50Hz, **M** – 110V 50Hz, **B** – 230/240V 50Hz, **J** – 400/415V 50Hz.  
 Other voltages available on application.  
 Replacement coils are not available.

**C3/C7 AUXILIARY CONTACT BLOCKS**

4A 400/415V AC15

TYPE	CONTACTS		Mini Contactor	Control Relay
	Normally open	Normally closed	LIST No	LIST No
2 pole	–	2	40000/M2S ▲	40600/C2S ▲
	1	1	40000/M2X ▲	40600/C2X ▲
	2	–	–	40600/C2T ▲
4 pole	–	4	–	40600/C4N ◆
	1	3	40000/M4P ◆	40600/C4P ◆
	2	2	40000/M4B ◆	40600/C4B ◆
	3	1	40000/M4C ◆	40600/C4C ◆
	4	–	–	40600/C4A ◆



40000/M2X

40000/M4B

▲ Suitable for C3 &amp; C7 ◆ Suitable for C7 only

**C7 MECHANICAL INTERLOCK**

Locates on top of two C7 mini contactors holding the two devices directly adjacent to one another. Auxiliary contact blocks can still be fitted on top of the mechanical interlock.

DESCRIPTION	LIST No
Mechanical interlock	42000/4

 42000/4  
 Shown fitted to contactors

Dimensions – see pages 32–33 Specification – see pages 27–28  
 Overload Relays – see page 9

**DIRECT-ON (TRIPLE POLE) CONTACTORS**

TYPE	RATING PER POLE (A)			AUXILIARY POLES		
	AC1 non inductive	AC3 inductive	Approx motor kW rating at 400/415V 3Ph	N/O	N/C	LIST No
<b>AC COIL OPERATED</b>						
C10	20	8.3	4	1	-	53400/Z_ 53400/Y_
C14	20	11	5.5	1	-	54400/Z_ 54400/Y_
C19	25	14	7.5	1	-	55400/Z_ 55400/Y_
C22	35	22	11	-	-	56400/Z_
C30	40	28	15	-	-	57400/Z_
C43	75	40	22	1	1	48400/X_
C63	85	55	30	1	1	49400/X_



**Coil selection** Complete the List No. of the contactor selected by adding the appropriate coil code letter.  
Preferred ac coils are **M** - 110V 50Hz, **B** - 230/240V 50Hz, **J** - 400/415V 50Hz with a full listing on page 11.

**REVERSING CONTACTORS**

with electrical & mechanical Interlock

TYPE	RATING		LIST No
	AC3	Approx motor kW rating at 400/415V 3Ph	
<b>AC COIL OPERATED</b>			
C10	8.3	4	53200/0_
C14	11	5.5	54200/0_
C19	14	7.5	55200/0_
C22	22	11	56200/0_
C30	28	15	57200/0_
C43	40	22	48200/0_
C63	55	30	49200/0_

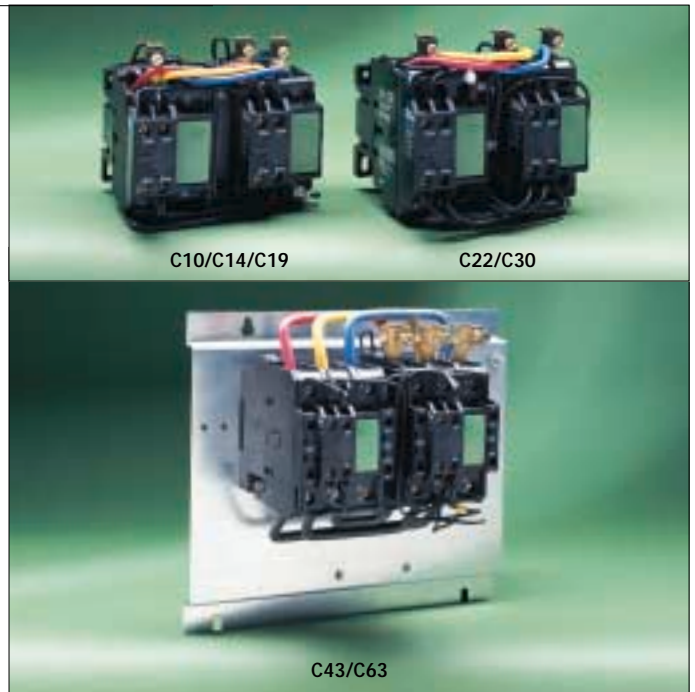

**Coil selection** Complete the List No. of the contactor selected by adding the appropriate coil code letter.  
Preferred ac coils are **M** - 110V 50Hz, **B** - 230/240V 50Hz, **J** - 400/415V 50Hz with a full listing on page 11.

**STAR-DELTA CONTACTORS**

with electrical & mechanical Interlock

TYPE	RATING		LIST No
	AC3	Approx motor kW rating at 400/415V 3Ph	
<b>AC COIL OPERATED</b>			
C19	24	11	55300/0_
C22	38	20	56300/0_
C30	48	25	57300/0_
C43	69	37	48300/0_
C63	95	55	49300/0_



Star Delta Contactors include electronic timer (adjustable 3-45s).  
**Coil selection** Complete the List No. of the contactor selected by adding the appropriate coil code letter. Preferred ac coils are **M** - 110V 50Hz, **B** - 230/240V 50Hz, **J** - 400/415V 50Hz with a full listing on page 11.

## OVERLOAD RELAYS

- Direct mounting onto appropriate contactor type.
- Differential tripping mechanism.
- Ambient temperature compensation.
- Manual/Automatic reset facility.
- Front mounted current adjustment dial.

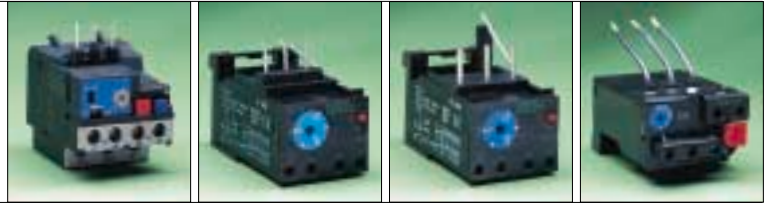

APPROX MOTOR kW RATING		APPROX MOTOR HP RATING		Overload relay rating (A)	C3 - C7 contactor mounting	C10 - C19 contactor mounting	C22 - C30 contactor mounting	C43 - C63 contactor mounting
Single phase 230/240V	Three phase 400/415V	Single phase 230/240V	Three phase 400/415V					
<b>DIRECT-ON STARTING</b>					LIST NO.	LIST NO.	LIST NO.	LIST NO.
-	0.12	-	0.16	0.3-0.45	<b>51500/DC</b>	-	-	-
-	0.18	-	0.25	0.45-0.67	<b>51500/EC</b>	-	-	-
-	0.25	-	0.33	0.67-1.0	<b>51500/FC</b>	-	-	-
0.06	0.37	0.08	0.5	1.0-1.5	<b>51500/GC</b>	-	-	-
0.09	0.55	0.12	0.75	1.4-2.1	<b>51500/HC</b>	-	-	-
0.12	0.75	0.16	1.0	1.8-2.7	<b>51500/IC</b>	-	-	-
0.25	1.1	0.33	1.5	2.4-3.6	<b>51500/JC</b>	-	-	-
0.37	1.5	0.50	2.0	3.5-5.0	<b>51500/KC</b>	-	-	-
0.55	2.2	0.75	3.0	4.0-6.0	<b>51500/LC</b>	-	-	-
0.75	4	1.0	5.5	5.5-8.5	<b>51500/MC</b>	-	-	-
1.5	5.5	2.0	7.5	8.5-12.5	<b>51500/NC</b>	-	-	-
<hr/>								
-	0.06	-	0.08	0.15-0.25	-	<b>55500/BC</b>	<b>57500/BC</b>	-
-	0.12	-	0.16	0.24-0.40	-	<b>55500/CC</b>	<b>57500/CC</b>	-
-	0.18	-	0.25	0.38-0.63	-	<b>55500/DC</b>	<b>57500/DC</b>	-
-	0.25	-	0.33	0.6-1.0	-	<b>55500/FC</b>	<b>57500/FC</b>	-
0.06	0.55	0.08	0.75	0.96-1.6	-	<b>55500/GC</b>	<b>57500/GC</b>	-
0.09	1.1	0.12	1.5	1.5-2.5	-	<b>55500/HC</b>	<b>57500/HC</b>	-
0.37	1.5	0.50	2	2.4-4.0	-	<b>55500/JC</b>	<b>57500/JC</b>	-
0.75	2.2	1.0	3	3.8-6.3	-	<b>55500/KC</b>	<b>57500/KC</b>	-
1.1	4	1.5	5.5	6.0-10.0	-	<b>55500/MC</b>	<b>57500/MC</b>	-
2.2	7.5	3.0	10	9.6-16.0	-	<b>55500/NC</b>	<b>57500/NC</b>	-
<hr/>								
3.7	11	5.0	15	15.0-25.0	-	-	<b>57500/PC</b>	-
5.5	22	7.5	30	24.0-40.0	-	-	<b>57500/QC</b>	-
<hr/>								
3	11	4	15	13-21	-	-	-	<b>49500/AD</b>
3.7	12.5	5	17	16-25	-	-	-	<b>49500/BD</b>
4	15	5.5	20	21-32	-	-	-	<b>49500/CD</b>
5.5	22	7.5	30	25-40	-	-	-	<b>49500/DD</b>
7.5	25	10	34	32-50	-	-	-	<b>49500/ED</b>
-	30	-	40	50-63	-	-	-	<b>49500/FD</b>
<hr/>								
<b>STAR-DELTA STARTING</b>								
-	2.2	-	3	4.1-6.9	-	<b>55500/JC</b>	<b>57500/JC</b>	-
-	4	-	5.5	6.5-10.9	-	<b>55500/KC</b>	<b>57500/KC</b>	-
-	7.5	-	10	10.3-17.2	-	<b>55500/MC</b>	<b>57500/MC</b>	-
-	11	-	15	16.5-27.6	-	<b>55500/NC</b>	<b>57500/NC</b>	-
<hr/>								
-	22	-	30	25.8-43.3	-	-	<b>57500/PC</b>	-
-	37	-	50	41.5-69	-	-	<b>57500/QC</b>	-
<hr/>								
-	18.5	-	25	23-36	-	-	-	<b>49500/AD</b>
-	22	-	30	28-43	-	-	-	<b>49500/BD</b>
-	30	-	40	37-55	-	-	-	<b>49500/CD</b>
-	37	-	50	44-69	-	-	-	<b>49500/DD</b>
-	45	-	60	56-87	-	-	-	<b>49500/ED</b>
-	59	-	80	87-109	-	-	-	<b>49500/FD</b>

## CONTROL RELAYS

4A 400/415V AC15

TYPE	CONTACTS		LIST No
	N/O	N/C	
<b>AC coil operation</b>			
C10	4	-	53600/A_
	2	2	53600/B_
	3	1	53600/C_

**Coil selection** Complete the List No. of the control relay selected by adding the appropriate coil code letter.

Preferred ac coils are **M** – 110V 50Hz, **B** – 230/240V 50Hz, **J** – 400/415V 50Hz as per list on page 11 for C10-30.



## MECHANICAL INTERLOCKS

TYPE	LIST No
C10-C30	57000/4
C43/C63	49000/4



## AUXILIARY CONTACTS

- Top mounting units are 4A 400/415V AC15
- Side mounting are 3A 400/415V AC15
- Units for enclosed starters have a "shallow" design to reduce overall height
- Correct selection of auxiliary contact will ensure that terminal markings comply with regulations
- Use the selection table to choose the correct auxiliary contact unit to suit the contactor or control relay according to application
- Side mounting auxiliary contacts are suitable for right hand side mounting only

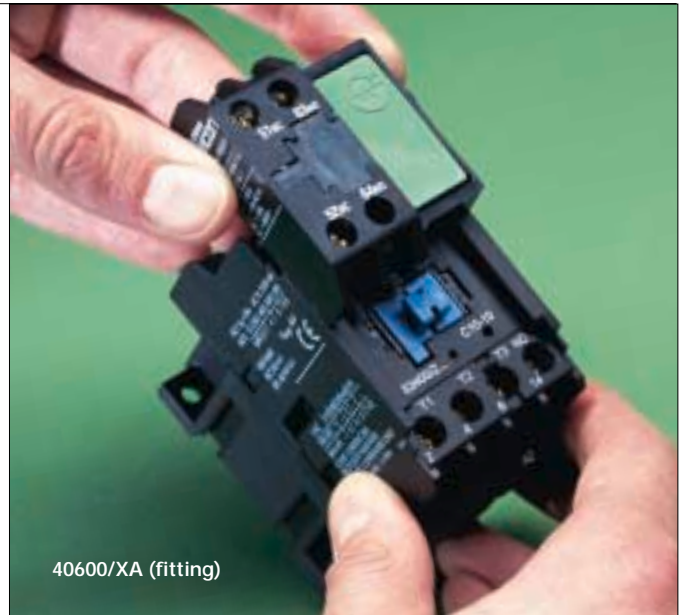

N/O	N/C	Start Switch	Top Mounting			Top Mounting	Side Mounting		Top Mounting
			For Open C10- C19 Contactors	For Open C22- C30 Contactors	For Open C43- C63 Contactors	For C10-C63 Enc. Starters	For C10-C19 Contactors	For C22-C30 Contactors	For Control Relays
0	1	-	-	-	-	-	50000/D01	50000/E01	-
1	0	-	-	-	-	-	50000/D10	50000/E10	-
0	4	-	-	-	-	-	-	-	50600/A04
4	0	-	-	-	-	-	-	-	50600/A40
1	0	1	-	-	-	40600/XA	-	-	-
0	1	1	-	-	-	40600/XC	-	-	-
0	2	-	50000/A02	50000/B02	50000/C02	-	-	-	50600/A02
1	1	-	50000/A11	50000/B11	50000/C11	40600/XB	-	-	50600/A11
1	3	-	50000/A13	50000/B13	-	-	-	-	50600/A13
2	2	-	50000/A22	50000/B22	-	-	-	-	50600/A22
3	1	-	50000/A31	50000/B31	50000/C31	-	-	-	50600/A31
0	3	-	-	-	-	-	-	-	50600/A03
1	2	-	-	-	-	-	-	-	50600/A12
2	0	-	-	-	-	-	-	-	50600/A20
2	1	-	-	-	-	-	-	-	50600/A21
3	0	-	-	-	-	-	-	-	50600/A30

Dimensions – see pages 32-33

## SPARE AND REPLACEMENT AC OPERATING COILS

When ordering contactors or starters, the coil voltage is specified by adding to the basic list number the appropriate coil code letter from the table of coils.

e.g. if List No.54400/Z (C14 contactor) is required with a 230/240V 50Hz operating coil, the code letter **B** should be added, ie 54400/ZB. Preferred coils (fitted to contactors and starters normally held in stock) are **M** (110V 50Hz), **B** (230/240V 50Hz) and **J** (400/415V 50Hz). Coils for other voltages and frequencies are available as outlined in the tables below.

Please note that early model C10-C30 contactors use a two terminal coil, and later models use a three terminal coil. Visual inspection of the contactor will easily show which version coil is required.

### AC OPERATING COILS



Coil code	Coil rating (V)		2 Terminal	3 Terminal	
	50Hz	60Hz	C10-C30 LIST No.	C10-C30 LIST No.	C43-C63 LIST No.
X	12	-	57000/EX	57000/EX3	-
P	24	-	57000/EP	57000/EP3	49000/EP
N	50	-	57000/EN	57000/EN3	49000/EN
R	-	110	57000/ER	57000/ER3	-
M	110	120	57000/EM	57000/EM3	49000/EM
L	200	-	57000/EL	57000/EL3	-
Q	-	220	57000/EQ	57000/EQ3	49000/EQ
A	220	-	57000/EA	57000/EA3	49000/EA
B	230/240	-	57000/EB	57000/EB3	49000/EB
T	346	-	57000/ET	57000/ET3	-
E	365	-	57000/EE	57000/EE3	-
K	380	-	57000/EK	57000/EK3	49000/EK
F	400	-	57000/EF	57000/EF3	-
J	400/415	-	57000/EJ	57000/EJ3	49000/EJ
G	440	-	57000/EG	57000/EG3	49000/EG
H	500	-	57000/EH	57000/EH3	49000/EH



### STAR-DELTA ELECTRONIC TIMER

DESCRIPTION	INPUT (V) 50/60HZ	LIST No
CEICON Electronic Timing Relay for star-delta contactor supplied with 1 NC contact.	50-55	56600/QN
Nominal setting range 3-45 secs. (DIN rail mounting only)	105-150	56600/QM
	180-240	56600/QB
	250-290	56600/QC
	330-400	56600/QE
<i>As used with types C19-C63,</i>	380-440	56600/QJ
<i>List Nos. 55300/Q_ to 49300/Q_.</i>	460-500	56600/QH

### ACCESSORIES

DESCRIPTION	TYPE	LIST No
Extension terminals	C10-C19	56000/2
	C22-30	57000/2
	C43-C63	49000/2
Main contact sets	C43	48000/ZA
	C63	49000/ZA

*One List No. comprises:  
set of 6 fixed & 3 moving contacts  
as required per contactor.*

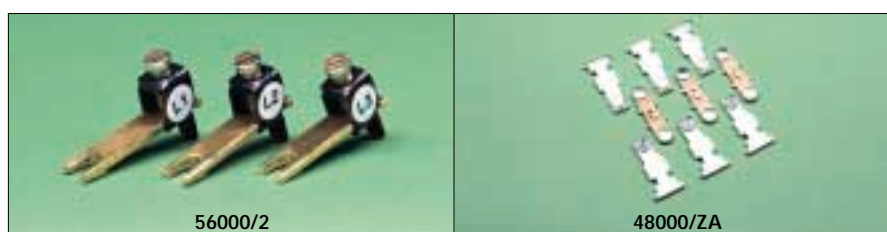

Dimensions - see pages 32-33

## MANUAL MOTOR STARTERS

Manual Motor Starters are a new addition to the Crabtree range complimenting Ceicon. Ideal for panel builders requiring a compact solution to motor control including integral short circuit and overload protection.

An enclosure and a full range of accessories make them suitable for use as standalone starters for local control of motors on intermittent duty.



## MANUAL MOTOR STARTERS

LIST No	Setting range (A)	Operating current of short-circuit release (A)	Rated ultimate short-circuit breaking capacity (IEC 947-2 EN 60947-2) and Max. backup fuse Icu (kA)/gL <sub>a</sub> M(Δ)			
			230V	400V	500V	690V
<b>CMS25-0.16</b>	0.1 - 0.16	1.9				
<b>CMS25-0.25</b>	0.16 - 0.25	2.6				
<b>CMS25-0.4</b>	0.25 - 0.4	4.4				
<b>CMS25-0.63</b>	0.4 - 0.63	8				
<b>CMS25-1</b>	0.63 - 1	11				
<b>CMS25-1.6</b>	1 - 1.6	19				
<b>CMS25-2.5</b>	1.6 - 2.5	30			3/25	2.5/20
<b>CMS25-4</b>	2.5 - 4	42			3/35	2.5/25
<b>CMS25-6.3</b>	4 - 6.3	69			3/50	2.5/35
<b>CMS25-10</b>	6.3 - 10	110			6/80	3/50 2.5/35
<b>CMS25-16</b>	10 - 16	210	6/80	4/80	2.5/63	2/35
<b>CMS25-20</b>	16 - 20	220	6/80	4/80	2.5/63	2/50
<b>CMS25-25</b>	20 - 25	330	6/80	4/80	2.5/63	2/50

Switches are short-circuit proof for any value of prospective current  $I_{cc}$



CMS25-6.3

CMS25-10

## ACCESSORIES

Auxiliary contacts	N/O	N/C	LIST No
	2	0	<b>CPS20</b>
	1	0	<b>CPS10</b>
	0	1	<b>CPS01</b>
	1	1	<b>CPS11</b>



CPS11

CPS20

Shunt Trip & Undervoltage Release	Voltage 50Hz	Shunt Trip	UVR
	24	<b>CA24</b>	<b>CU24</b>
	48	<b>CA48</b>	<b>CU48</b>
	110	<b>CA110</b>	<b>CU110</b>
	230	<b>CA230</b>	<b>CU230</b>
	400	<b>CA400</b>	<b>CU400</b>



CA110

CU24

## IP55 ENCLOSURE

Note: Enclosure is supplied with IP55 membrane. In the case of an Emergency Stop or padlock facility being fitted, IP rating will be IP40.

	<b>CO-55</b>
--	--------------



CO-55

## ENCLOSURE ACCESSORIES

	LIST No
Emergency Stop Pushbutton	<b>CNAT</b>
Padlocking Device	<b>CZ</b>
Pushbuttons Membrane	<b>CM</b>
Additional Neutral/Earth link	<b>CNL</b>
Signal Lamp 230V Red	<b>CSSR230</b>

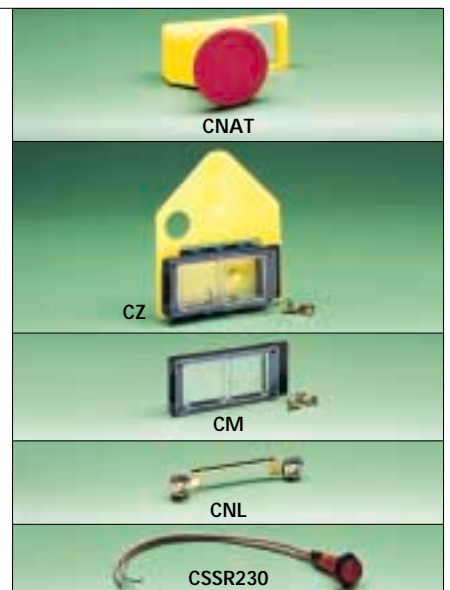

CNAT

CZ

CM

CNL

CSSR230

Dimensions – see page 34

## SILENT OPERATION INSTALLATION CONTACTORS

Another new addition to the control equipment range, these DIN rail mounted contactors with silent operation are ideal for mounting in control panels destined for either residential or commercial dwellings where quiet running is a priority. Suitable for heating, lighting, air-conditioning, motors and similar equipment.





## SILENT OPERATION INSTALLATION CONTACTORS

TYPE	Thermal Rating per Pole AC1(A)	Motor Rating AC3 (kW)		Pole Configuration		LIST No
		230V	400V	N/O	N/C	
CIK22	20	1.3 (N/O only)	-	2	0	<b>CIK22-20</b> <b>CIK22-11</b> <b>CIK22-02</b>
				1	1	
				0	2	
CIK24	24	2.2	4	4	0	<b>CIK24-40</b> <b>CIK24-31</b> <b>CIK24-22</b> <b>CIK24-04</b>
				3	1	
				2	2	
				0	4	
CIK40	40	5.5	11	4	0	<b>CIK40-40</b> <b>CIK40-31</b> <b>CIK40-22</b> <b>CIK40-04</b>
				3	1	
				2	2	
				0	4	
CIK63	63	8.5	15	4	0	<b>CIK63-40</b> <b>CIK63-31</b> <b>CIK63-22</b> <b>CIK63-04</b>
				3	1	
				2	2	
				0	4	
Auxiliary Contacts	230V 400V AC15					
	6	4	-	-	1 2	1 0

### MAXIMUM NUMBER OF LAMPS PER POLE

TYPE		CIK22	CIK24	CIK40	CIK63
Incandescent lamps	60W	21	25	65	85
	100W	13	15	40	50
	200W	7	7	20	25
	500W	3	3	8	10
	1000W	1	1	4	5
Energy saving lamps	7W	10	15	100	150
	11W	10	15	100	150
	15W	5	15	100	150
	20W	3	10	70	70
Halogen lamps	200W	-	5	15	20
	300W	-	3	10	13
	500W	-	2	6	8
	1000W	-	1	3	4
Low pressure sodium-vapour lamps (uncompensated)	35W	5	6	13	20
	55W	5	6	13	20
	90W	3	4	9	14
	135W	2	3	6	9
	180W	3	3	6	9
High pressure sodium-vapour lamps (uncompensated)	50W	12	12	24	38
	70W	10	10	20	30
	110W	8	7	16	25
	150W	6	5	10	16
	250W	3	3	6	10
	400W	2	2	4	6
	1000W	1	-	2	3
Low pressure sodium-vapour lamps (compensated)	35W	1	1	10	16
	55W	1	1	10	16
	90W	-	1	8	12
	135W	-	-	4	7
	180W	-	-	4	7
High pressure sodium-vapour lamps (compensated)	50W	3	3	22	33
	70W	2	3	18	27
	110W	2	2	18	27
	150W	1	1	10	16
	250W	-	1	6	9
	400W	-	-	4	7
	1000W	-	-	2	3
Fluorescent lamps (uncompensated)	18W	24	24	90	140
	36W	17	20	65	95
	58W	10	13	40	60
Fluorescent lamps (compensated)	18W	6	8	45	70
	36W	6	8	45	70
	58W	4	5	25	43
Fluorescent lamps (dual fitted)	18W	2 x 22	2 x 48	2 x 100	2 x 150
	36W	2 x 17	2 x 24	2 x 65	2 x 95
	58W	2 x 10	2 x 15	2 x 40	2 x 60
Fluorescent lamps with electronic starting device AC - operation	1 x 18W	22	30	60	80
	1 x 36W	12	16	30	42
	1 x 58W	8	12	22	30
	2 x 18W	23	32	40	48
	2 x 36W	12	16	20	26
	2 x 58W	7	10	10	18

Dimensions – see page 35

## R22 22.5mm COMMAND DEVICES

The revised R22 range of command devices includes a broad range of components to offer numerous solutions to the control of low voltage circuits. A variety of popular ready assembled product combinations complete the range.

For Panel mounting select: (see inset)

1. Actuator/device
2. Legend if required
3. Contact block support
4. Front mounted contact block(s)  
/other device eg.lampholder



For R22 enclosure mounting select:

1. Actuator/device
2. Legend if required
3. Enclosure
4. Base mounted contact block  
(no contact block  
support is required).

## INSULATED ASSEMBLED PUSH BUTTON UNITS

Supplied complete in an all-insulated IP65 enclosure with:

- Knockouts on side walls for ease of installation.
- Actuators affixed to the cover whilst the contact blocks are arranged for enclosure base mounting.
- Contact blocks, fitted with upward-facing terminals, can be pre-wired and then snapped to the enclosure base.
- Stop actuators are provided with a normally closed contact.
- Start, for, rev & selector switch actuators include a normally open contact.

DESCRIPTION	LIST No
1 Button START	<b>1/MB</b>
1 Button STOP	<b>1/MBS</b>



1 Button mushroom head STOP	<b>1/MBM</b>
1 Button mushroom head autolock STOP	<b>1/MBA</b>



1 Button mushroom head autolock STOP key reset	<b>1/MBAK</b>
Key switch 0-1	<b>1/MBK</b>



2 Button START/STOP	<b>2/MB</b>
2 Button START/mushroom head STOP	<b>2/MBM</b>



2 Button START/mushroom head autolock STOP	<b>2/MBA</b>
3 Button FOR/REV/STOP	<b>3/MB</b>



Emergency Jumbo Mushroom Head push button station **22EV90**



Alternatively, actuator combinations to the customer's choice can be selected by ordering individual enclosures, contact blocks and actuators – R22 Range, see pages 19–21.

Dimensions – see page 36 Specification – see page 36

## HEAVY DUTY METALCLAD ASSEMBLED PUSH-BUTTON UNITS

Supplied complete in a robust diecast enclosure with:

- 1 Earth terminal      2 Box & cover fixings outside gasket
- 3 Captive screws      4 IP65 gasket

- Stop actuators are provided with one normally closed contact.
- All other actuators have one normally open contact.

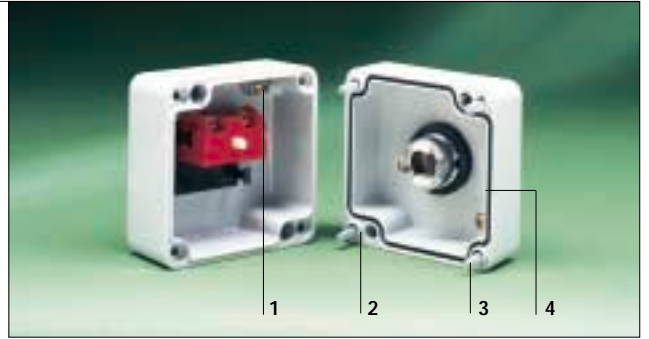

1 STATION UNITS	LIST No
1 button START	22931/GV
1 button STOP	22931/RV
Keyswitch 0-1	22931/K2V
Keyswitch 0-1, spring return to centre	22931/SK2V
Mushroom STOP	22931/MV
Autolock STOP	22931/AV
Autolock STOP, key reset	22931/AKV
Jumbo Autolock STOP	22931/AJV
Mushroom STOP with half collar shroud	22931/MHCV
Autolock STOP with half collar shroud	22931/AHCV
Autolock STOP, key reset with half collar shroud	22931/AKHCV

2 STATION UNITS	LIST No
UP/DOWN	22932/UDV
START/STOP	22932/SV
START/Mushroom STOP	22932/MV
START/Autolock STOP	22932/AV

3 STATION UNITS	LIST No
UP/DOWN, with Mushroom STOP	22933/MUDV
FOR/REV/Mushroom STOP	22933/MFRV
START/Mushroom STOP with Green Pilot Light, (220-240V neon)	22933/MPLV
4 STATION UNIT	LIST No
START/Mushroom STOP Red and Green Pilot Lights, (220-240V neons)	22934/M2PLV



One additional contact block can be fitted per actuator position except Autolock STOP with key reset.

Dimensions – see page 36 Specification – see page 36

**NON ILLUMINATED PUSH BUTTONS IP65**

	Colour	LIST No	
		Metal	Plastic
Flush Button	Black	22MR1	22ER1
	Red	22MR2	22ER2
	Green	22MR3	22ER3
	Yellow	22MR4	22ER4
	Blue	22MR5	22ER5
	White	22MR6	22ER6
Extended Button	Black	22MRR1	22ERR1
	Red	22MRR2	22ERR2
	Green	22MRR3	22ERR3
	Yellow	22MRR4	22ERR4
	Blue	22MRR5	22ERR5
	White	22MRR6	22ERR6
Push on - Push off Button	Black	22MR/PP1	22ER/PP1
	Red	22MR/PP2	22ER/PP2
	Green	22MR/PP3	22ER/PP3
	Yellow	22MR/PP4	22ER/PP4
	Blue	22MR/PP5	22ER/PP5
	White	22MR/PP6	22ER/PP6
Mushroom head button - 40mm	Black	22MF1	22EF1
	Red	22MF2	22EF2
	Green	22MF3	22EF3
Mushroom head with auto lock - 40mm	Red	22MFB2	22EFB2
Mushroom head with switching after auto lock (BSEN418) - 40mm	Red	22MFBC2	22EFBC2
Mushroom head with auto lock key reset - 40mm	Red	22MFC2	22EFC2
Push on - push off mushroom head - 40mm	Black	22MFB/PP1	22EFB/PP1
	Red	22MFB/PP2	22EFB/PP2
	Green	22MFB/PP3	22EFB/PP3
Jumbo mushroom head button - 60mm	Red	22MFBA2	22EFBA2
Reset button	White	22MRESET	22RESET



**ILLUMINATED PUSH BUTTONS IP65**

	Colour	LIST No	
		Metal	Plastic
Illuminated flush Button	Red	22MRL2	22ERL2
	Green	22MRL3	22ERL3
	Yellow	22MRL4	22ERL4
	Blue	22MRL5	22ERL5
	White	22MRL6	22ERL6
	Push on - push off illuminated flush button	Red	22MRL-PP2
Green		22MRL-PP3	22ERL-PP3
Yellow		22MRL-PP4	22ERL-PP4
Blue		22MRL-PP5	22ERL-PP5
White		22MRL-PP6	22ERL-PP6
Illuminated mushroom head auto lock button - 40mm		Red	22MFBL2
Illuminated push on - push off mushroom head button	Red	22MFBL-PP2	22EFBL-PP2
	Green	22MFBL-PP3	22EFBL-PP3
Illuminated mushroom head button	Red	22MFL2	22EFL2
	Green	22MFL3	22EFL3
Pilot light	Red	22ML2	22EL2
	Green	22ML3	22EL3
	Yellow	22ML4	22EL4
	Blue	22ML5	22EL5
	White	22ML6	22EL6
	Monobloc pilot light	Red	
Green			22ELE3
Yellow			22ELE4
Blue			22ELE5
White			22ELE6



SELECTOR SWITCHES



	LIST No		
	Metal	Plastic	
<b>Maintained left - right</b> Standard selector switch (black) Illuminated selector switch (red) Key selector switch (black)	22MS1A 22MSL-L2A 22MSCA/J	22ES1A 22ESL-L2A 22ESCA/J	
<b>Maintained middle - right</b> Standard selector switch (black) Illuminated selector switch (red) Key selector switch (black)	22MS1CD 22MSL-L2CD 22MSCCD/J	22ES1CD 22ESL-L2CD 22ESCCD/J	
<b>Momentary middle - right</b> Standard selector switch (black) Illuminated selector switch (red) Key selector switch (black)	22MS1CD/R 22MSL-L2CD/R 22MSCCD/R/V	22ES1CD/R 22ESL-L2CD/R 22ESCCD/R/V	
<b>Maintained left - middle - right</b> Standard selector switch (black) Illuminated selector switch (red) Key selector switch (black)	22MS1E 22MSL-L2E 22MSCE/J	22ES1E 22ESL-L2E 22ESCE/J	
<b>Momentary left and right</b> Standard selector switch (black) Illuminated selector switch (red) Key selector switch (black)	22MS1E/RC 22MSL-L2E/RC 22MSCE/RC/V	22ES1E/RC 22ESL-L2E/RC 22ESCE/RC/V	
<b>Maintained left - momentary right</b> Standard selector switch (black) Illuminated selector switch (red) Key selector switch (black)	22MS1E/RD 22MSL-L2E/RD 22MSCE/RD/X	22ES1E/RD 22ESL-L2E/RD 22ESCE/RD/X	
<b>Momentary left - maintained right</b> Standard selector switch (black) Illuminated selector switch (red) Key selector switch (black)	22MS1E/RS 22MSL-L2E/RS 22MSCE/RS/Z	22ES1E/RS 22ESL-L2E/RS 22ESCE/RS/Z	

▼ = direction of spring return (momentary) □ = key removable position for key switches

JOY STICK SELECTOR SWITCHES



	LIST No		
	Metal	Plastic	
<b>2 Position maintained</b> Standard with lock release	22MM2F 22MMB2F	22EM2F 22EMB2F	
<b>2 Position momentary</b> Standard with lock release	22MM2R 22MMB2R	22EM2R 22EMB2R	
<b>4 Position maintained</b> Standard with lock release	22MM4F 22MMB4F	22EM4F 22EMB4F	
<b>4 Position momentary</b> Standard with lock release	22MM4R 22MMB4R	22EM4R 22EMB4R	

▼ = direction of spring return (momentary)

### DUAL PUSH BUTTONS

Dual push button black-black with indicator	Plastic	22EPD/F
Dual push button green-red (extended) O-I	Plastic	22EPDR/O-I
Dual push button green-red O-I	Plastic	22EPD/O-I
Dual illuminated push button green-red O-I	Plastic	22EPDL/O-I
Dual illuminated push button black-black with indicator	Plastic	22EPDL/F
Dual illuminated push button green-red (extended) O-I	Plastic	22EPDLR/O-I



### POWER SUPPLIES

Direct power supply	Plastic	22ECD
Power supply with flasher 24V	Plastic	22ECL/24
Power supply with flasher 130V	Plastic	22ECL/130
Power supply with flasher 230V	Plastic	22ECL/230
Power supply with transformer 110/6V	Plastic	22ECT/110
Power supply with transformer 230/6V	Plastic	22ECT/230
Power supply with transformer 400/6V	Plastic	22ECT/400



### CONTACT BLOCKS

Contact block support	Plastic	22EB
Normally open front mounting (panel)	Plastic	22EC/NO
Normally closed front mounting (panel)	Plastic	22EC/NC
Normally open rear mounting (for R22 enclosure)	Plastic	22EC/NO-EV
Normally closed rear mounting (for R22 enclosure)	Plastic	22EC/NC-EV



### IP65 ENCLOSURES

Insulated enclosure-Yellow-1 button hole	Plastic	22EVG1
Insulated enclosure-Grey-1 button hole	Plastic	22EV1
Insulated enclosure-Grey-2 button hole	Plastic	22EV2
Insulated enclosure-Grey-3 button hole	Plastic	22EV3



Metal enclosure-Yellow-1 button hole	Metal	22EVK-1/G
Metal enclosure-Grey-1 button hole	Metal	22EVK-1
Metal enclosure-Grey-2 button holes	Metal	22EVK-2
Metal enclosure-Grey-3 button holes	Metal	22EVK-3
Metal enclosure-Grey-4 button holes	Metal	22EVK-4



Protection cap for flush buttons	Plastic	22ERPR
Protection cap for illuminated flush buttons	Plastic	22ERPL
Protection cap for mushroom head buttons - 40mm	Plastic	22ERPF
Protection cap for dual push buttons	Plastic	22ERPD
Protection cap for extended dual push buttons	Plastic	22ERPDR



Legend Plate 30x40	Plastic	22EQ8
Legend Plate 30x50	Plastic	22EQ15
Legend Plate 30x40	Metal	22EQ16
Legend Plate 30x45	Metal	22EQ21



Yellow stop legend 40mm	Plastic	22ED40
Yellow stop legend 60mm	Plastic	22ED60
Yellow stop legend 90mm	Plastic	22ED90



### LEGEND PLATES & ANCILLARIES

Legend	List No.	Legend	List No.	Legend	List No.	Legend	List No.		
OPEN	22641	FORWARD	22637	0	1	22650	FAST	22643	
CLOSE	22642	REVERSE	22638	2	0	1	22651	SLOW	22644
UP	22639	START	22636	AUTO	0	MAN	22652	INCH	22645
DOWN	22640	STOP	22635	OFF	ON	22654	RESET	22648	
							RUN	22646	



### ANCILLARIES

Padlockable cover (for flush/extended buttons)	LIST No	22054
Mushroom half collar shroud		220HC/K
Blanking plug for unused holes		22T22
Earth terminal for metal body actuators		220Z



220HC/K suitable for all enclosures except List Nos. 22EV2 & 22EV3. Spare keys on application.

## MOTOR CIRCUIT SWITCHES

An all new selection of motor circuit switches from 16A to 80A fully rated for AC23. The range includes compact triple pole switches for panel mounting with a full range of accessories including switched and fixed 4<sup>th</sup> poles, auxiliaries, handles, extension shafts and shrouds. The range is completed with ready assembled versions in either all insulated or metal base enclosures, both to IP65.



**TP & N ENCLOSED MOTOR CIRCUIT SWITCHES**

Rating (A)			List Numbers			
AC21	AC23	415V/kW	All Insulated IP65	Box Size	Metal Base IP65	Box Size
16	16	7.5	<b>15416/11</b>	<b>A</b>	<b>16/MS</b>	<b>0</b>
25	25	9	<b>15425/11</b>	<b>A</b>	<b>25/MS</b>	<b>0</b>
32	32	11	<b>15432/11</b>	<b>B</b>	<b>32/MS</b>	<b>0</b>
40	40	11	<b>15440/11</b>	<b>B</b>	<b>40/MS</b>	<b>0</b>
63	63	15	<b>15463/11</b>	<b>C</b>	<b>63/MS</b>	<b>1</b>
80	80	22	<b>15480/11</b>	<b>D</b>	<b>80/MS</b>	<b>1</b>



**PANEL MOUNTED MOTOR CIRCUIT SWITCHES**

Rating (A)			TP Switch	List Numbers	
AC21	AC23	415V/kW		Switched 4th pole	Fixed N pole
16	16	7.5	<b>15416</b>	<b>19016</b>	<b>19963</b>
25	25	9	<b>15425</b>	<b>19025</b>	<b>19963</b>
32	32	11	<b>15432</b>	<b>19032</b>	<b>19963</b>
40	40	11	<b>15440</b>	<b>19040</b>	<b>19963</b>
63	63	15	<b>15463</b>	<b>19063</b>	<b>19963</b>
80	80	22	<b>15480</b>	<b>19080</b>	<b>199125</b>

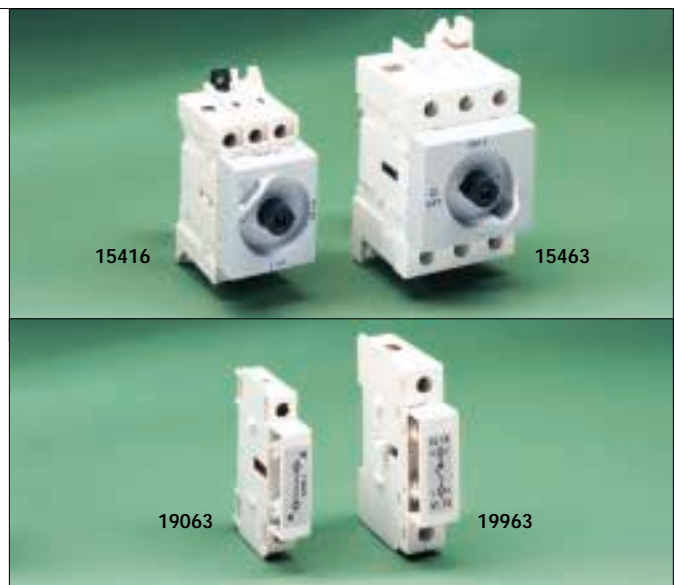

**ACCESSORIES**

Description	List No
Auxiliary contact (10A)	<b>19701</b>
Door Interlocked Handle Red/Yellow	<b>15045</b>
Door Interlocked Handle Black/Grey	<b>15046</b>
Shaft Extension 55mm	<b>15055</b>
Shaft Extension 70mm	<b>15070</b>
Shaft Extension 90mm	<b>15090</b>
Shaft Extension 150mm	<b>15150</b>
Shaft Extension 200mm	<b>15200</b>
Shaft Extension 300mm	<b>15300</b>
16-40A SP Terminal Shroud	<b>19811</b>
16-40A TP Terminal Shroud	<b>19813</b>
63-80A SP Terminal Shroud	<b>19821</b>
63-80A TP Terminal Shroud	<b>19823</b>

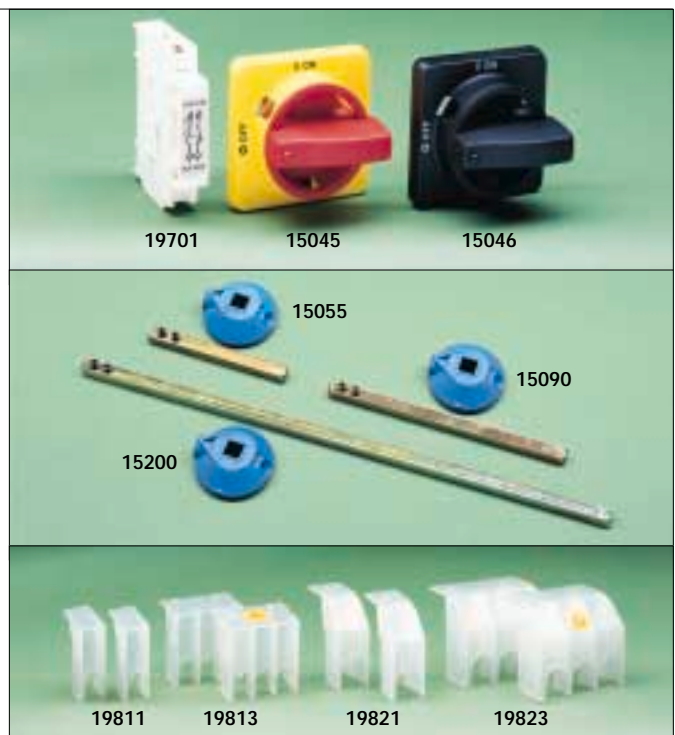

Dimensions – see page 37 Specification – see page 37

## POSITION SWITCHES

A proven range of standard and positive opening (safety) switches with a choice of operating actuator heads. Standard switches are available with either "snap" or "slow" action contact blocks. Positive opening switches are supplied complete and coloured red for visual identification.



**POSITION SWITCHES**

The range comprises a robust ebony grey die-cast aluminium enclosure with grooves for easy location of a snap-action or slow-action contact block. Four operating head styles optimise product application. The fully interchangeable actuator heads can be rotated through four 90° positions to suit a variety of mounting applications. In addition the rod lever and roller lever patterns can be modified on site to operate right of centre only or left of centre only as an alternative to the normal operation mode of both sides of the centre position.

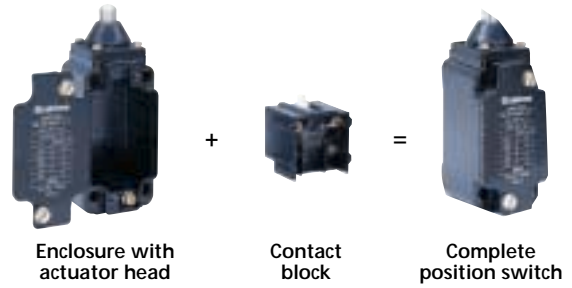

**Rounded plunger**  
LIST No  
**15045/1**

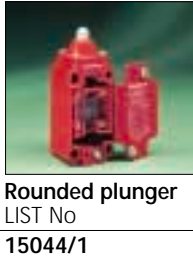

**Rounded plunger**  
LIST No  
**15044/1**

**APPROXIMATE DIMENSIONS (mm)**  
**ROUNDED PLUNGER ACTUATOR (FORM B)**

LIST No	A	B	C	D	E	F	G	H	J	K	L
<b>15045/1</b>	108	42	45	60	30	17	38	16.5	-	10	5.3
<b>15044/1 (safety)</b>	108	42	45	60	30	17	38	16.5	-	12	5.3

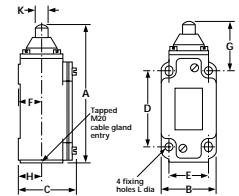

**Roller plunger**  
LIST No  
**15045/2**



**Roller plunger**  
LIST No  
**15044/2**

**ROLLER PLUNGER ACTUATOR (FORM C)**

LIST No	A	B	C	D	E	F	G	H	J	K	L
<b>15045/2</b>	121	42	45	60	30	17	51	16.5	16	4	5.3
<b>15044/2 (safety)</b>	121	42	45	60	30	17	51	16.5	16	4	5.3

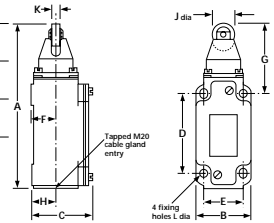

**Rod lever**  
LIST No  
**15045/3**

**ROD LEVER ACTUATOR (FORM D)**

LIST No	A	B	C	D	E	F	G	H	J	K	L
<b>15045/3</b>	112	42	45	60	30	56.2	200	16.5	9.5	6	5.3

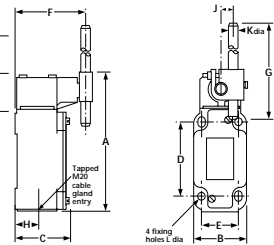

**Roller lever**  
LIST No  
**15045/5**

**ROLLER LEVER ACTUATOR (FORM A)**

LIST No	A	B	C	D	E	F	G	H	J	K	L
<b>15045/5</b>	137	42	45	60	30	58.5	67	16.5	20	5	5.3

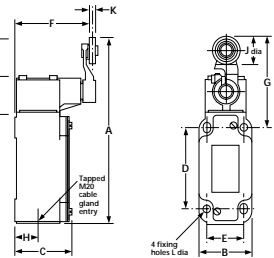

Note: Safety position switches 15044/1 and 15044/2 are supplied complete with contact block

**CONTACT BLOCKS**

**Snap action** has double-break four-terminal changeover poles of the same polarity. Changeover contact operation occurs instantaneously at a pre-determined point. The moulding is fitted with a transparent cover which permits visual examination of the contacts.

**Slow action** has double-break four-terminal electrically-separate changeover poles, and ideally allows for connection of low voltage alarm circuits. Contact operation is determined by the speed and travel of the actuator. The moulding is fitted with a transparent cover which permits visual examination of the contacts.



**Snap-action**  
LIST No  
**15040**



**Slow-action**  
LIST No  
**15042**

**SPECIFICATION (ALL POSITION SWITCHES)**

Standards (type tests)	IEC 947-5-1 BSEN 60947-5-1	Back up protection HRC fuse & MCB (current limiting)	6A
Rated impulse withstand voltage ( $U_{imp}$ )	2.5kV	Cable termination, max conductor size	2x1.5 or 1x2.5mm <sup>2</sup>
Mechanical durability (no of operations)	30 million	Enclosure degree of protection to BSEN60529:	1992 IP66
Electrical durability (no of operations – full load)	500,000	Rated operating current (AC15)	V 24 48 110 240 415
Maximum frequency of actuation per hour	3,600		A 6 4 3 2 1.6

# TECHNICAL DATA

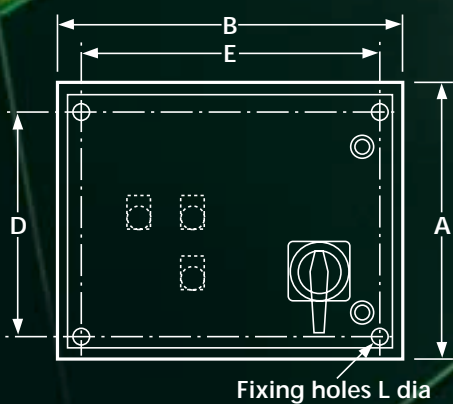
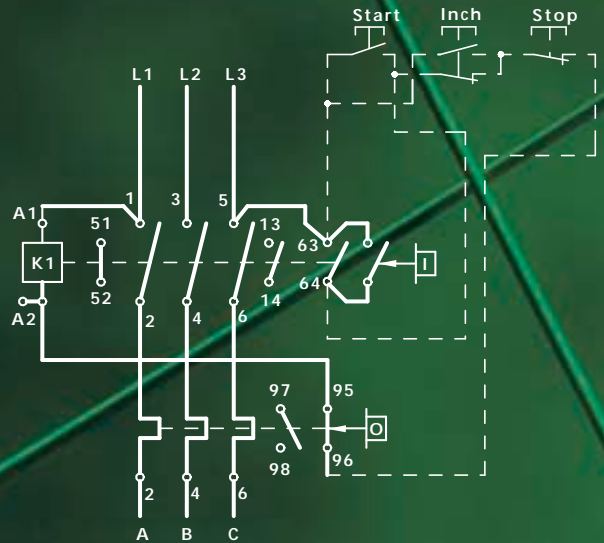
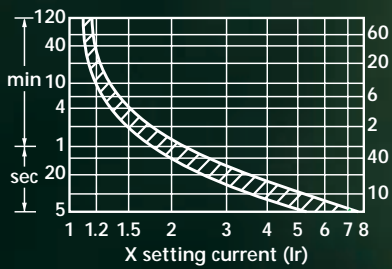

## CONTACTOR SPECIFICATION

FEATURES	UNITS	C3	C7	C10	C14	C19	C22	C30	C43	C63
Main poles		3	3	3	3	3	3	3	3	3
Auxiliary poles - standard		1	1	1	1	1	0	0	2	2
Rated impulse withstand voltage (Uimp)	Kv	6	6	6	6	6	6	6	6	6
Rated impulse withstand voltage (Ui) - main poles	V	690	690	690	690	690	690	690	690	690
Rated impulse withstand voltage (Ui) - Aux. poles	V	690	690	690	690	690	-	-	690	690
Rated operational current (Ie) 400/415V 50Hz										
AC1 Non-inductive (@45 degrees)	A	20	20	25	25	25	35	35	75	85
AC3 Squirrel cage motors - normal switching	A	5	8.5	8.5	11	14	22	28	40	55
AC4 Squirrel cage motors - plugging/inching	A	5	8.5	8.5	8.3	11	14	22	28	40
Other ratings										
Conventional thermal rating (Ith) open @45 degrees)	A	20	20	25	25	25	35	35	75	85
Star-delta starter	A	-	-	14.4	19	24	-	-	69	95
Transformer primary switching	A	5	5.7	8.3	10	11	-	-	32	36
Tungsten and infra red lamps	A	-	4.5	8.5	10	13	-	-	37	48
Non-compensated high-pressure mercury, sodium vapour and halide lamps	A	-	8.5	8.5	11	18	-	-	44	50
Compensated high-pressure mercury, sodium vapour and halide lamps	A	-	4.5	4.5	7	14	-	-	22	24
Capacitor switching (single bank only) 400/415V	kVAr	-	-	-	-	-	-	-	17	25
Mechanical durability - number of operations	x10 <sup>6</sup>	10	10	10	10	10	10	10	3	3
Maximum operations per hour (AC3)		3000	3000	3000	3000	3000	3000	3000	3000	3000
Maximum HRC back up fuse links (50kA)										
-Type 2 co-ordination	A	20	20	-	-	-	-	-	-	-
-Type 1 co-ordination	A	25	25	25	25	35	50	50	80	125
Rating of auxiliary poles and relays (AC15)										
- 230/240V (Built in aux pole)	A	6	6	6	6	6	-	-	6	6
- 400/415V	A	4	4	4	4	4	-	-	4	4
- 500V	A	2	2	2	2	2	-	-	2	2
Operating coil voltage range										
Consumption, ac coil variants										
- pull in	VA	37	32	66	66	66	66	66	130	130
- hold in	VA	5.5	5.5	8	8	8	8	8	10	10
Average operating times, ac coil variants										
- pick up	ms	6-12	6-12	-	-	-	-	-	10-20	10-20
- drop out	ms	5-10	5-10	-	-	-	-	-	8-15	8-15
Cable termination - maximum conductor size										
Main pole terminals										
- single or stranded	mm	2.5	2.5	4	4	4	10	10	35	35
- flexible	mm	2.5	2.5	2.5	2.5	2.5	6	6	25	25
Auxiliary pole terminals										
- single or stranded	mm	2.5	2.5	2.5	2.5	2.5	-	-	2.5	2.5
- flexible	mm	2.5	2.5	2.5	2.5	2.5	-	-	2.5	2.5
Ambient temperature limits - open	deg C	-20/+60	-20/+60	-20/+60	-20/+60	-20/+60	-20/+60	-20/+60	-20/+60	-20/+60
- enclosed	deg C	-20/+45	-20/+45	-20/+45	-20/+45	-20/+45	-20/+45	-20/+45	-20/+45	-20/+45
Weight	kg	0.16	0.18	0.3	0.3	0.3	0.32	0.32	0.93	0.93

## OVERLOAD RELAYS SPECIFICATION

	UNITS	51500/-	55500/-	57500/-	49500/-
Range - Direct on	A	0.3-12.5	0.15-16	0.15-40	0.15-40
- Star delta	A	-	4.1-27.6	4.1-69	23-109
Rated impulse withstand voltage (Uimp)	kV	6	6	6	6
Rated insulation voltage (Ui) - main poles	V	690	690	690	690
- auxiliary poles	V	500	500	500	500
Auxiliary contact rating					
AC15 -230/240V	A	2	3	3	2
- 400/415V	A	1	2	2	1
- 500V	A	0.5	1	1	0.5
Cable termination - maximum conductor size					
Main pole terminals					
- single or stranded	mm	4	16	16	25
- flexible	mm	4	10	10	16
Auxiliary pole terminals					
- single or stranded	mm	2.5	2.5	2.5	2.5
- flexible	mm	1.5	1.5	1.5	1.5
Control circuit fuse maximum (normal or slow)	A	6	10	10	6
Ambient temperature limits - open	deg C	-20/+55	-20/+60	-20/+60	-20/+55
- closed	deg C	-20/+55	-20/+40	-20/+40	-20/+55
Weight	kg	0.16	0.16	0.16	0.3
Maximum HRC back up fuse links (50kA)					
Type 1 or type 2 co-ordination					

HRC BACK-UP FUSE LINKS, OVERLOAD RELAY CHARACTERISTICS & CONTACT LIFE

CEICON C3-C63 OVERLOAD RELAYS

CEICON overload relays should be backed up by HRC fuse links selected from the following table. When selecting a motor rated fuse link the recommended rating relates to the largest rated current, eg for an application requiring a 50A fuse link, a motor rated fuse link marked 32M50 should be used.

OVERLOAD RELAY			FUSE LINK RATING (A)	
Type	LIST No series	Rating (A)	Type gL	MPSCC
C3/7	51500/DC	0.3-0.45	2	80kA
	51500/EC	0.45-0.67	2	80kA
	51500/FC	0.67-1.0	4	80kA
	51500/GC	1.0-1.5	6	80kA
	51500/HC	1.4-2.1	6	80kA
	51500/IC	1.8-2.7	10	80kA
	51500/JC	2.4-3.6	10	80kA
	51500/KC	3.5-5.0	16	80kA
	51500/LC	4.0-6.0	20	80kA
	51500/MC	5.5-8.5	20	80kA
	51500/NC	8.5-12.5	25	80kA
C10/30	55 or 57 500/BC	0.15-0.25	1	80kA
	55 or 57 500/CC	0.24-0.4	1	80kA
	55 or 57 500/DC	0.38-0.63	1	80kA
	55 or 57 500/FC	0.6-1	2	80kA
	55 or 57 500/GC	0.96-1.6	4	80kA
	55 or 57 500/HC	1.5-2.5	6	80kA
	55 or 57 500/JC	2.4-4	10	80kA
	55 or 57 500/KC	3.8-6.3	16	80kA
	55 or 57 500/LC	6-10	20	80kA
	55 or 57 500/MC	9.6-16	25	80kA
	57500/PC	15-25	50	80kA
	57500/QC	24-40	80	80kA
	C43/63	49500/AD	13-21	50
49500/BD		16-25	50	80kA
49500/CD		21-32	63	80kA
49500/DD		25-40	80	80kA
49500/ED		32-50	100	80kA
49500/FD		50-63	125	80kA

CEICON OVERLOAD RELAY CHARACTERISTICS

The 3-phase overload tripping characteristics are taken from a cold condition in an ambient temperature of 20°C and are therefore worst case curves. The tripping times should not be longer than those shown (it will be noted that they apply over a range: curves for individual units will operate within a narrower band). It should be noted that the best single phasing protection is obtained when the overload relay is operating at or near its maximum rating.

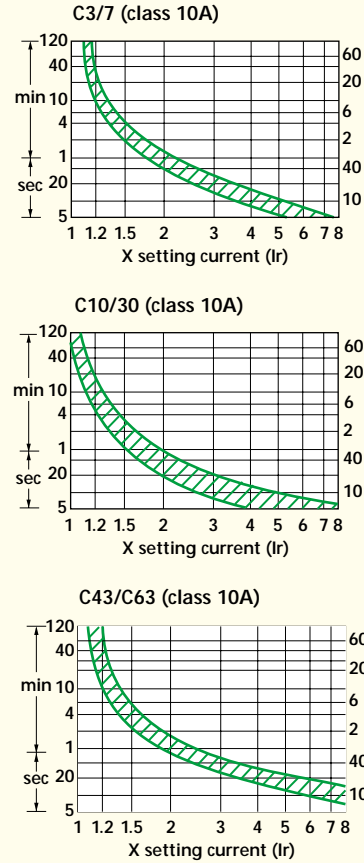

CONTACT LIFE FOR CEICON C3/181 CONTACTORS

Normal switching conditions for squirrel-cage motors  
Utilisation category AC3

OPERATING CHARACTERISTICS  
Switching on: From standstill 6xFLC of motor  
Switching off: While running 1xFLC of motor  
TYPICAL APPLICATIONS  
Compressors, lifts, mixers, sluices, pumps, escalators, stirrers, barrels, blowers, conveyors, centrifuges, air-conditioning, general drives on manufacturing and processing machinery

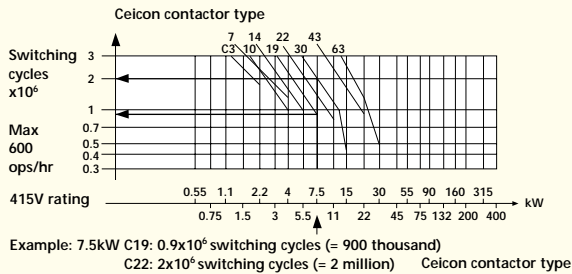

Severe conditions for squirrel-cage motors  
Utilisation category AC4

OPERATING CHARACTERISTICS  
Inching, reverse-power braking, plugging  
Switching on: 6xFLC of motor  
Switching off: 6xFLC of motor  
TYPICAL APPLICATIONS  
Printing presses, wire-drawing machines, centrifuges, special drives on manufacturing and processing machinery

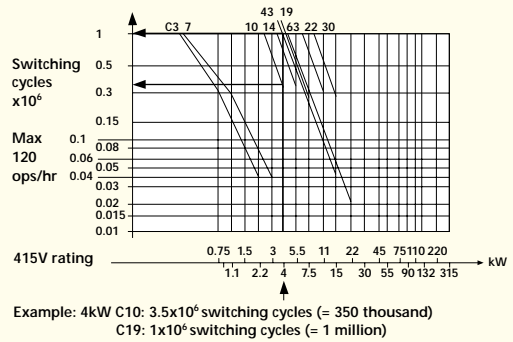

## C10-C30 DIRECT-ON STARTER

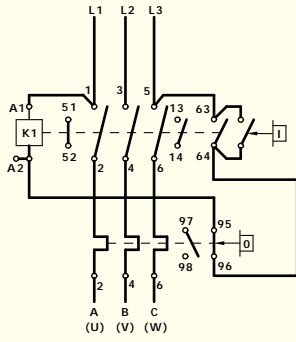

Connections for 3 phase 3 wire supply - as shown above

Connections for 3 phase 4 wire supply

1. Remove connection 1(L1) - A1
2. Connect neutral to terminal A1

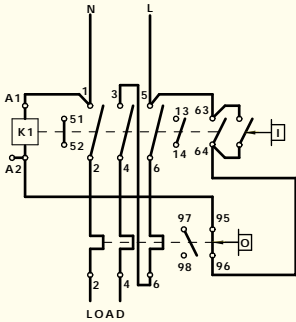

Connections for Single Phase Motors

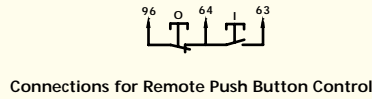

Connections for Remote Push Button Control

1. Remove connections 96 - 64
2. Connect as illustrated

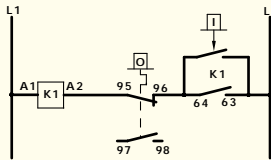

Schematic Diagram

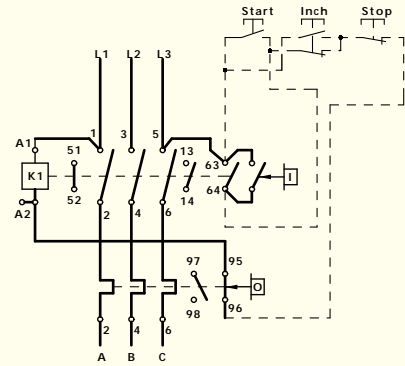

Connections for Remote Start-Inch-Stop Control

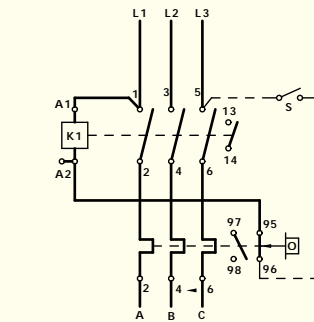

Connections for Remote Pilot Switch Control

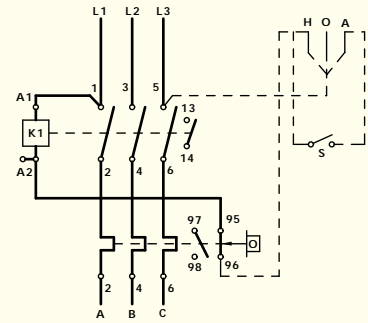

Connections for Remote Hand-Off-Auto Control

## C43-C63 DIRECT-ON STARTER

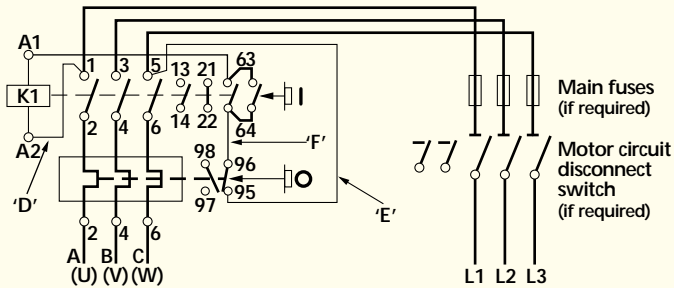

Remote push-button control

1. Omit connection F
2. Connect as illustrated

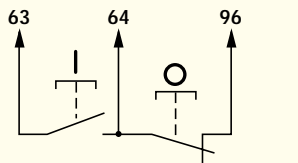

Connections for remote pilot switch control

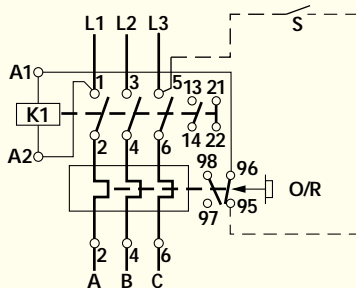

Connections for single phase motors

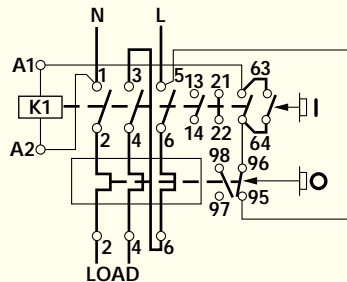

Schematic diagram

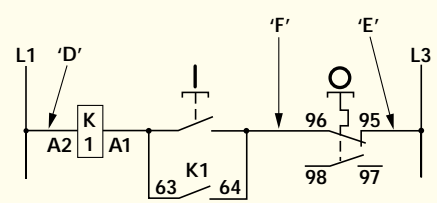

Connections for remote start inch stop control

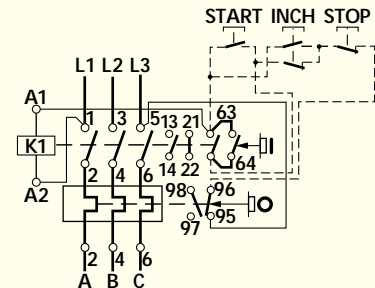
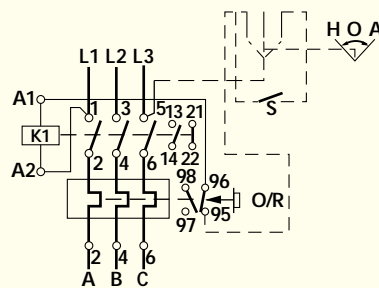

### Control circuit supply arrangements

SUPPLY	CONNECTIONS
Phase to phase	Connect as shown
Phase to neutral	Omit connection D Connect neutral to terminal A2 on coil
Separate	Omit connections D & E Connect separate coil supply feed to terminal A2 on coil & terminal 95 on overload relay

C10-C30 REVERSING STARTER

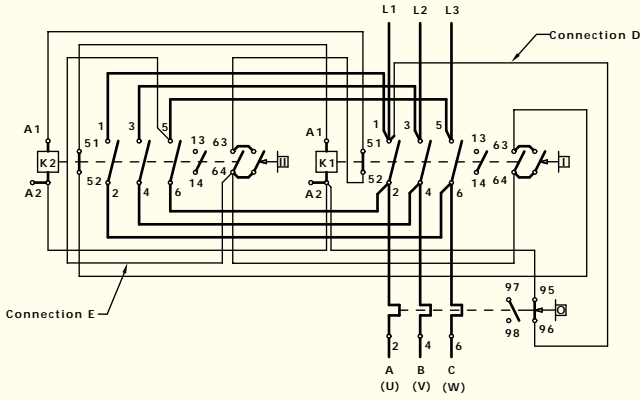

Note:-  
Auxiliary contact 13-14 fitted to C10-C19 contactors only as standard.

Control Circuit Supply Arrangements

SUPPLY	CONNECTIONS
Phase to Phase	Connect as shown
Phase to Neutral	Omit connection D Connect neutral to terminal 96
Separate	Omit connections D and E Connect separate coil supply to terminal 96 on overload and terminal 64 on contactor K2

Connections for Remote Push Button Control

- Omit connection D
- Connect as illustrated

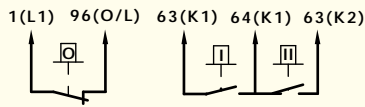

Connections if overtravel position switches are required

- Remove connections 52 to 63
- Connect as illustrated

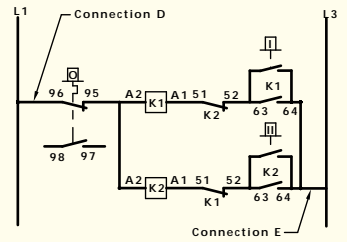
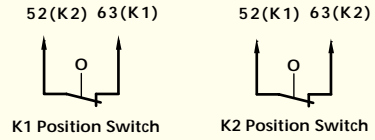

Schematic diagram

Push to Run

A simple push-to-run arrangement can be achieved in either or both directions by changing the top adder start switches.  
Contact Technical Services Dept

C43-C63 REVERSING STARTER

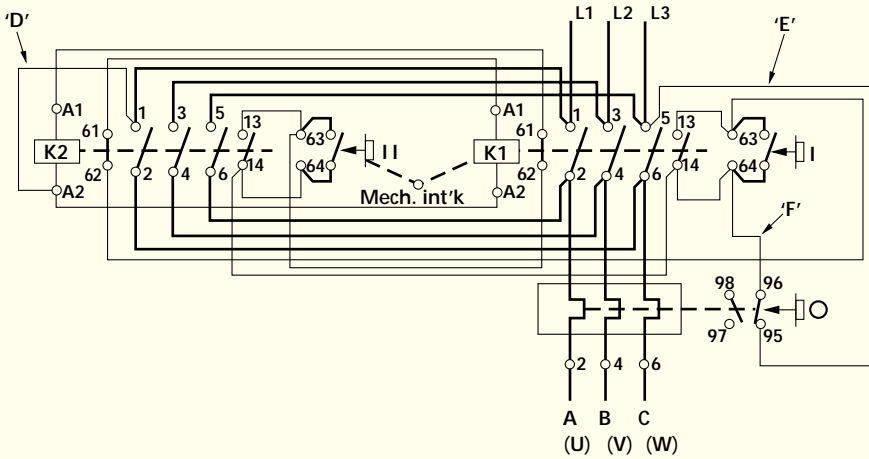

Push-to-run control

A simple push-to-run arrangement can be achieved in either or both directions by removing connections 13 to 63 as appropriate

Control circuit supply arrangements

SUPPLY	CONNECTIONS
Phase to phase	Connect as shown
Phase to neutral	Omit connection D Connect separate coil supply to terminal A2 on coil
Separate	Omit connections D & E Connect separate coil supply feed to terminal A2 on coil & terminal 95 on overload relay

Schematic diagram

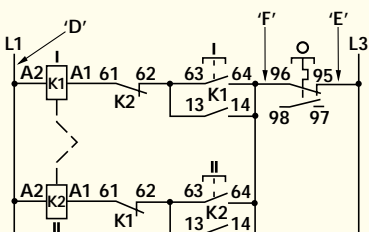

Connections for remote push-button control

- Connection F is omitted
- Connect as illustrated

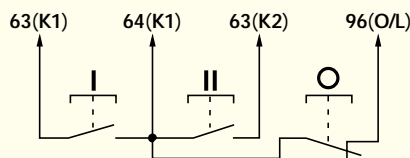

If overtravel position switches are required

- Remove connections 62 to 63
- Connect as illustrated

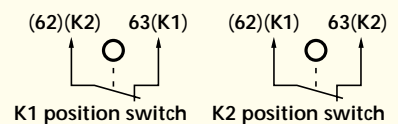

### C19-C30 STAR-DELTA STARTER

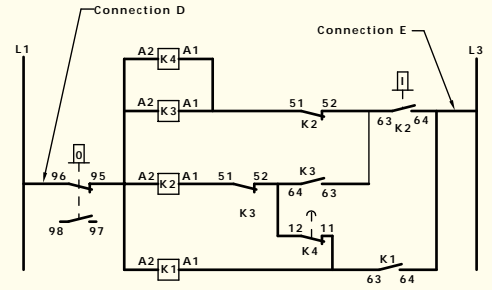
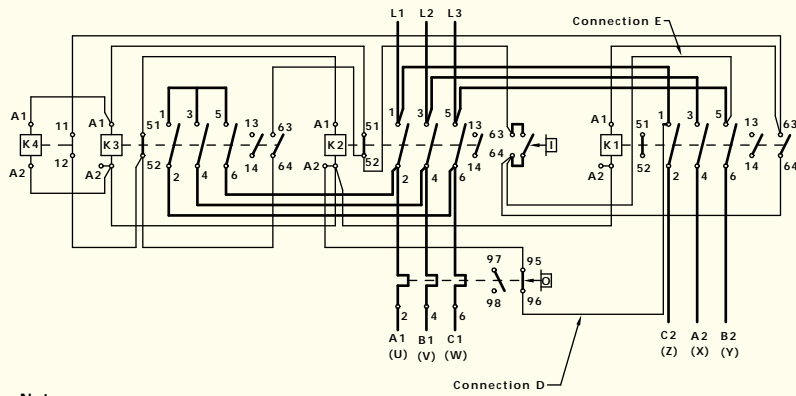

Schematic Diagram (Push Button Control)

Note:-

Auxiliary contact 13-14 fitted to C10-C19 contactors only as standard.

#### Control Circuit Supply Arrangements

Supply	Connections
Phase to Phase	Connect as shown
Phase to Neutral	Omit connection D Connect neutral to terminal 96
Separate	Omit connections D and E Connect separate coil supply to terminal 96 on overload and terminal 64 on contactor K2

#### Connections for Remote Push Button Control

- Omit connection D
- Connect as illustrated

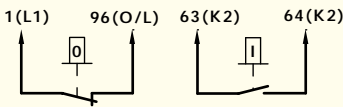

Motor Windings  
Connect to appropriate terminals on starter

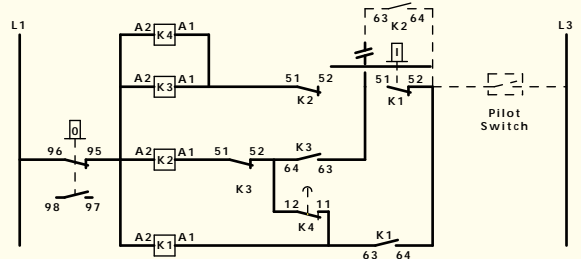
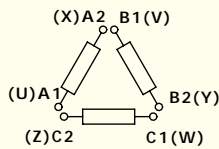

### C43-C63 STAR-DELTA STARTER

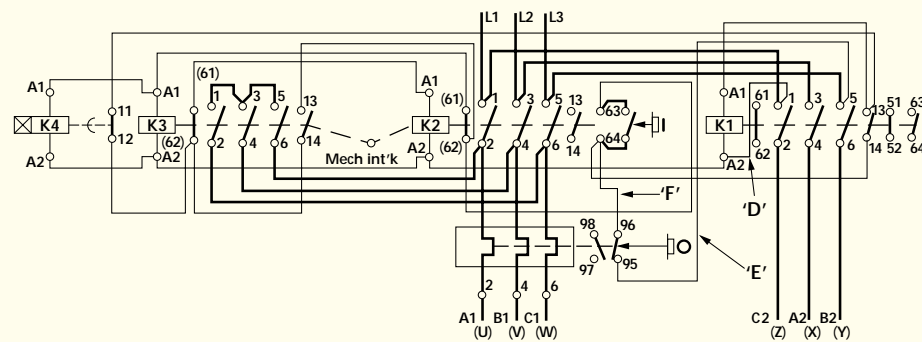

#### Remote pilot switch control schematic diagram

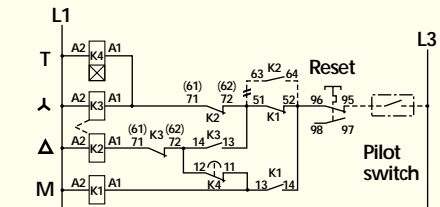

#### Connections for remote pilot switch control

- Remove connection 63 to (62) on K2 contactor
- Connect between 52 and 14 on K1 contactor and from terminals 51 on K1 contactor to terminal (62) on K2 contactor
- Connect pilot switch in place of connection E
- Set overload relay to hand reset position

#### Push-button control schematic diagram

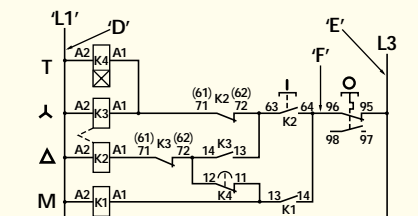

#### Control circuit supply arrangement

SUPPLY	CONNECTIONS
Phase to phase	Connect as shown
Phase to neutral	Omit connection D Connect neutral to terminal A2 on coil
Separate	Omit connections D & E Connect separate coil supply feed to terminal A2 on coil & terminal 95 on overload relay

#### Motor windings

Connect to appropriate terminals on starter.

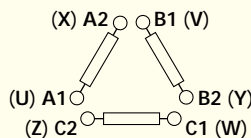

#### Connections for remote push-button (start/stop) control

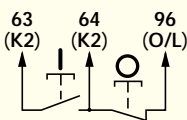

- Connection F is omitted
- Connect as illustrated

APPROXIMATE DIMENSIONS (mm)

ENCLOSURES FOR CONTACTORS & DIRECT-ON STARTERS

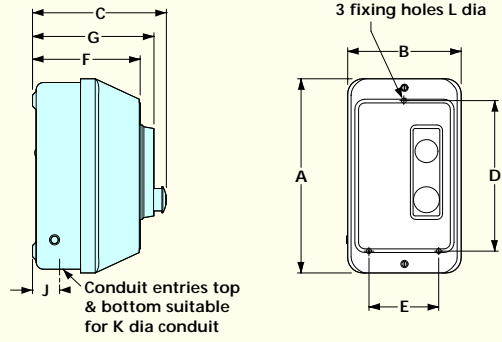

IP66	A	B	C	D	E	F	G	H	J	K	L
<b>C10/14/19 contactor</b>	212	124	-	164	76	117	-	-	29.5	3x20	5.5
<b>C10/14/19 direct-on</b>	212	124	146	164	76	117	132.5	-	29.5	3x20	5.5
<b>C22/30 contactor</b>	212	124	-	164	76	117	-	-	29.5	3x20	5.5
<b>C22/30 direct-on</b>	212	124	146	164	76	117	132.5	-	29.5	3x20	5.5
<b>C43/63 contactor</b>	260	158	-	210	108	132	-	-	27.5	2x20 1x25	5.5
<b>C43/63 direct-on</b>	260	158	160	210	108	132	147	-	27.5	2x20 1x25	5.5

ENCLOSURES FOR REVERSING & STAR-DELTA STARTERS

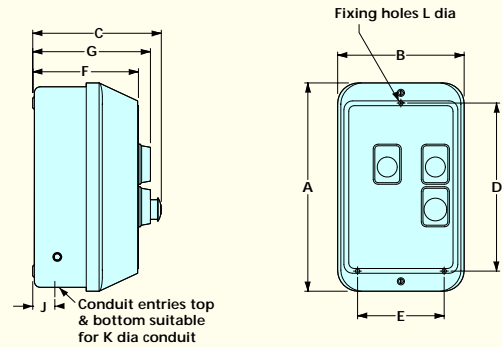

IP66	A	B	C	D	E	F	G	H	J	K	L
<b>C10/14/19/22/30 reversing</b>	260	158	160	210	108	132	147	-	27.5	2x20 1x25	3x5.5
<b>C19/22/30 star-delta</b>	260	230	161	210	180	133	148	-	28.5	2x20 1x25	4x5.5

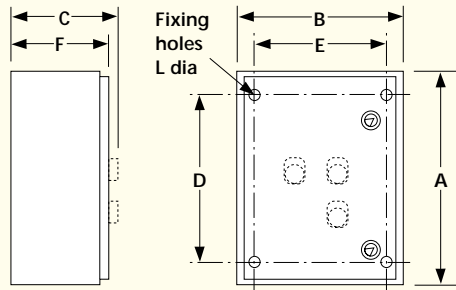

IP55	A	B	C	D	E	F	G	H	J	K	L
<b>C43/63 reversing</b>	400	300	209	350	250	177	-	-	-	-	8
<b>C43/63 star-delta</b>	400	300	209	350	250	177	-	-	-	-	8

Sheet steel enclosures are supplied with removable top and bottom gland plates.

ENCLOSURES WITH MOTOR CIRCUIT SWITCH FOR CONTACTORS, DIRECT-ON, REVERSING & STAR-DELTA STARTERS

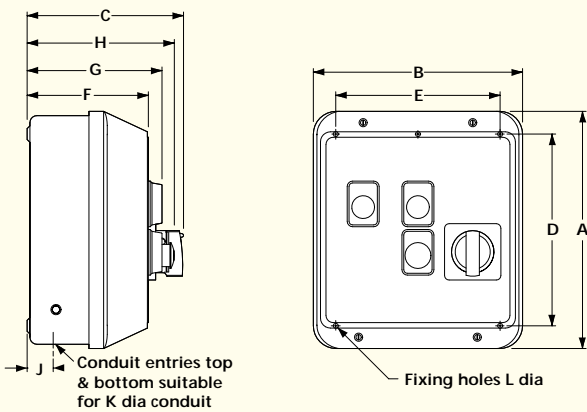

IP66	A	B	C	D	E	F	G	H	J	K	L
<b>C10/14/19/22/30 contactor + MCS</b>	212	124	156	164	78	117	-	-	29.5	3x20	3x5.5
<b>C10/14/19/22/30 direct-on + MCS</b>	212	124	156	164	76	117	132	146	29.5	3x20	3x5.5
<b>C10/14/19/22/30 reversing + MCS</b>	260	230	171	210	180	133	148	161	28.5	2x20 1x25	4x5.5
<b>C19/22/30 star-delta + MCS</b>	260	332	171	210	282	133	148	161	28.5	2x20 1x25	5.5

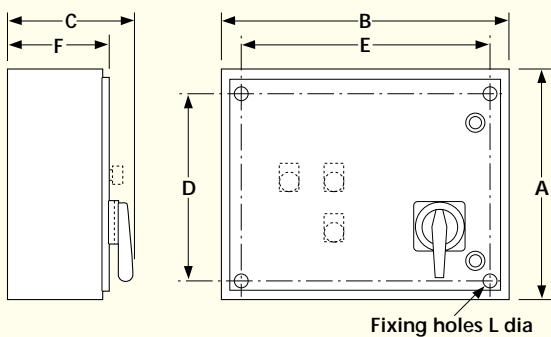

IP55	A	B	C	D	E	F	G	H	J	K	L
<b>C43/63 reversing</b>	400	500	222	350	450	177	-	-	-	-	8
<b>C43/63 star-delta</b>	400	500	222	350	450	177	-	-	-	-	8

Sheet steel enclosures are supplied with removable top and bottom gland plates.

**APPROXIMATE DIMENSIONS (mm)**

**CONTROL RELAYS & CONTACTORS**

	A	B	C	D	E	F	G	H	J	K	L
<b>C3</b>	62.5	35	49	50	25.5	26	-	-	-	-	4.1
<b>C7</b>	56.5	45	49	50	35	26	-	-	-	-	4.1

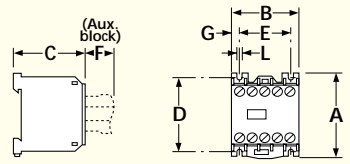

	A	B	C	D	E	F	G	H	J	K	L
<b>C10/14/19</b>	78.5	45	76.5	50	60	35	33	16	-	-	4.5
<b>C22/30</b>	78.5	45	86	50	60	35	33	16	-	-	4.5
<b>C43/63</b>	107	65	109	70	-	50	33	16	-	-	4.5

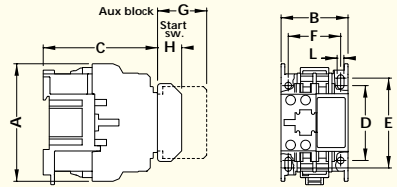

**DIRECT-ON STARTERS**

	A	B	C	D	E	F	G	H	J	K	L
<b>C7</b>	98	45	49	50	-	35	26	-	87	-	4.1
<b>C10/14/19</b>	121	45	76.5	50	60	35	33	16	87	-	4.5
<b>C22/30</b>	121	45	86	50	60	35	33	16	87	-	4.5
<b>C43/63</b>	170	65	109	70	-	50	33	16	124	-	4.5

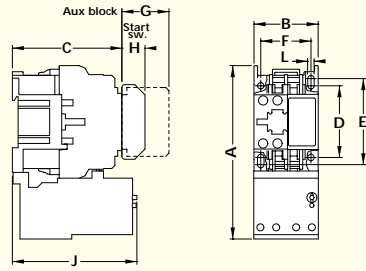

**REVERSING STARTERS**

For DIN rail or screw mounting	A	B	C	D	E	F	G	H	J	K	L
<b>C10/14/19</b>	134	105	76.5	50	60	35	33	16	87	60.2	4.5
<b>C22/30</b>	134	105	86	50	60	35	33	16	87	60.2	4.5

Supplied mounted on backplate	A	B	C	D	E	F	G	H	J	K	L
<b>C43/63</b>	-	-	-	-	-	50	33	-	-	-	-

	M	N	P	Q	R	S	T	U	V
	210	160	200	250	225	5.3	15	-	-

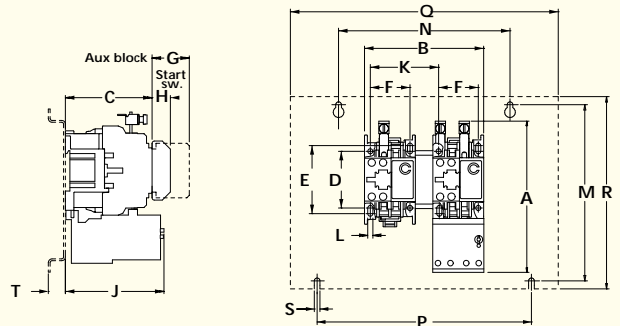

**STAR-DELTA STARTERS**

For DIN rail or screw mounting	A	B	C	D	E	F	G	H	J	K	L
<b>C10/14/19</b>	134	180	76.5	50	60	35	33	16	87	60.2	4.5

	M	N	P	Q	R	S	T	U	V
	-	-	-	-	-	-	56.7	-	-

Supplied mounted on backplate	A	B	C	D	E	F	G	H	J	K	L
<b>C22/30</b>	134	180	86	50	60	35	33	16	87	60.2	4.5

	M	N	P	Q	R	S	T	U	V
	-	-	-	-	-	-	56.7	-	-

Supplied mounted on backplate	A	B	C	D	E	F	G	H	J	K	L
<b>C43/63</b>	-	-	-	-	-	50	33	-	-	-	-

	M	N	P	Q	R	S	T	U	V
	210	160	200	250	225	5.3	15	70	-

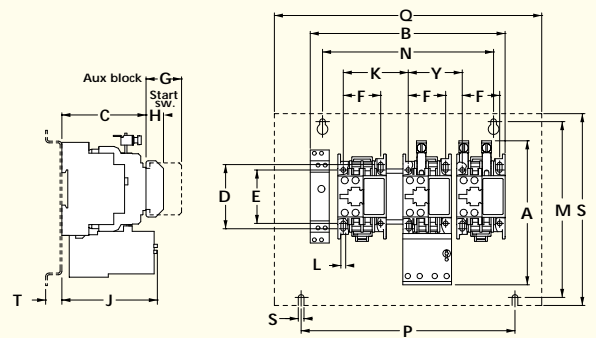

**ELECTRONIC TIMER FOR RAIL MOUNTING**

	A	B	C	D	E	F	G	H	J	K	L
<b>Electronic timer</b>	86	17.5	61	-	-	-	-	-	-	-	-

Fits 35mm DIN rail to BS5584: 1978, EN50 022-35.

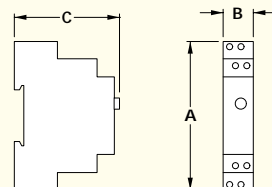

**DIMENSIONS CMS25 MANUAL MOTOR STARTER**

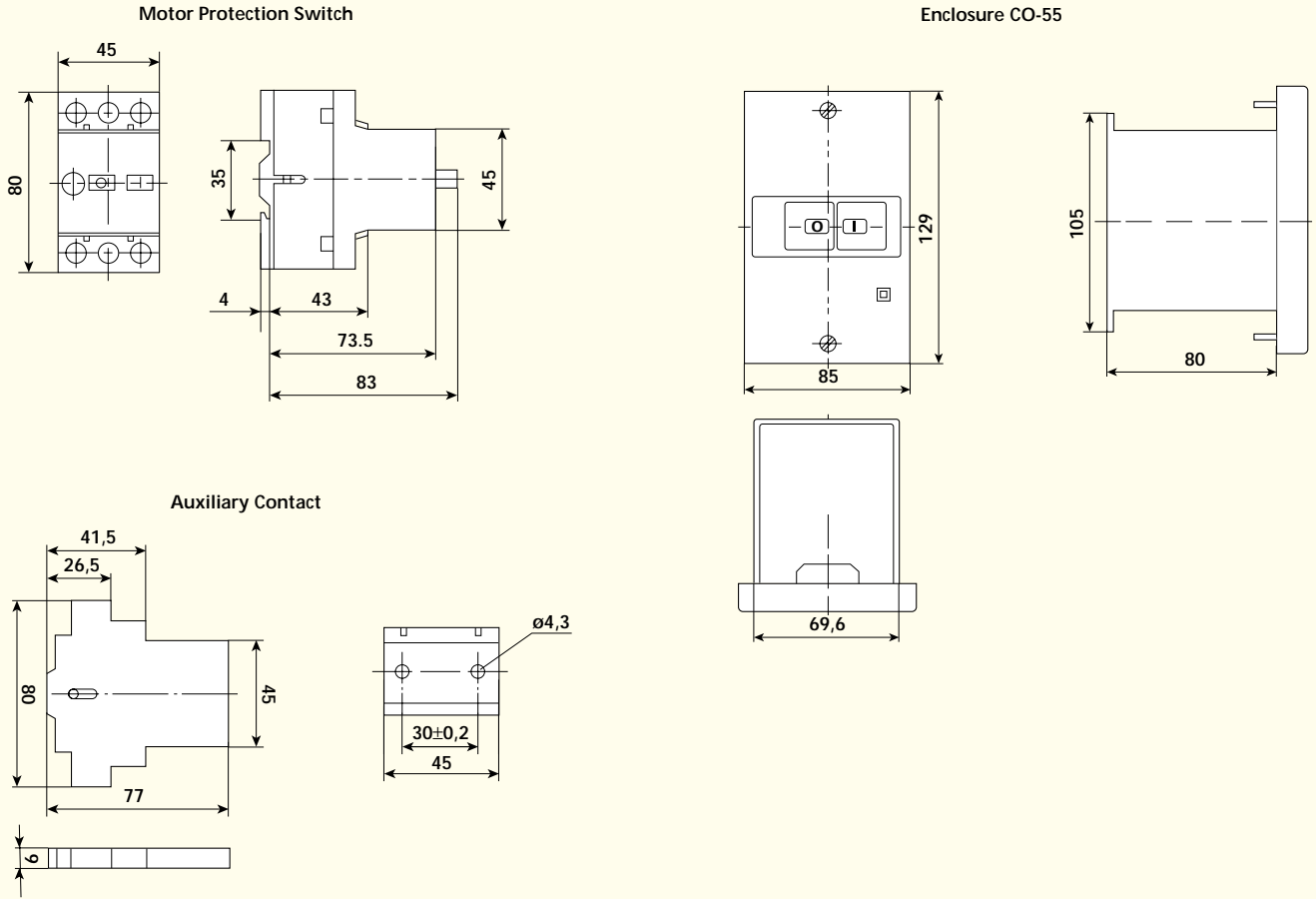

**TIME CURRENT CHARACTERISTIC CMS25**

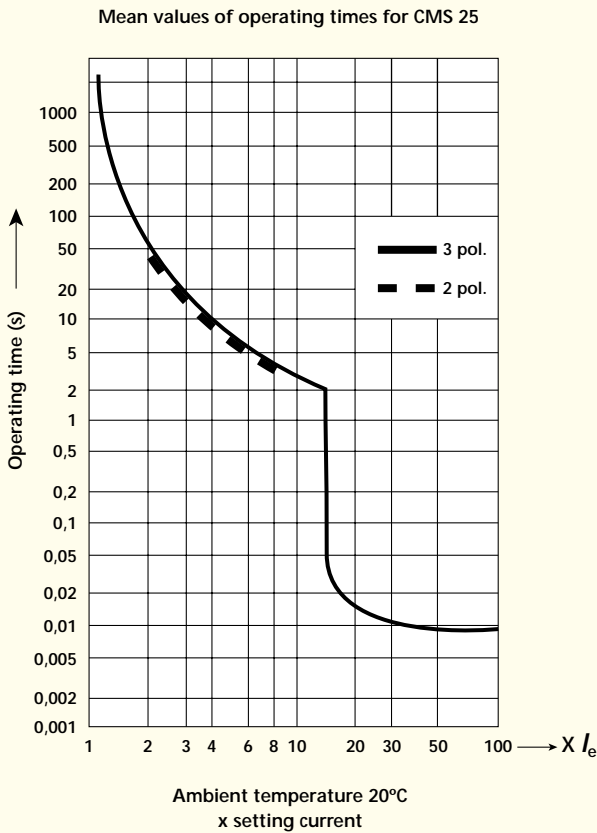

CIK22

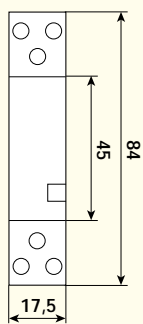

CIK24

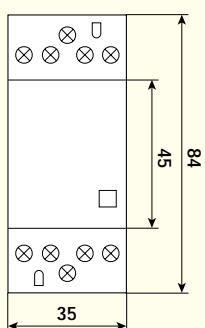

CIK40/CIK63

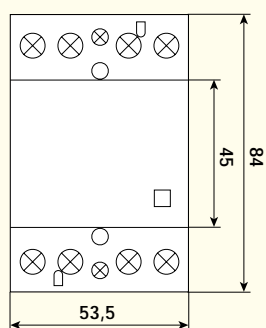

Side Elevation

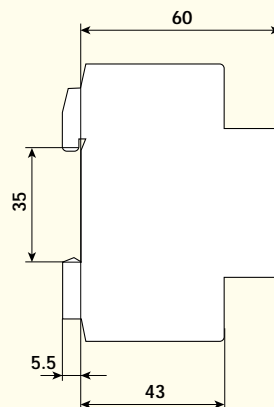

Auxiliary Switch CHHSLa

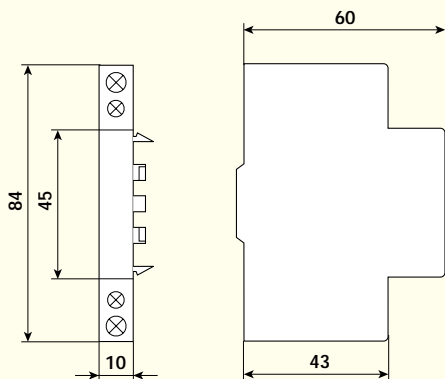

**CONNECTION DIAGRAMS**

**Control circuit**

- 230V 50/60 Hz AC
- Rectified Coil

Single Pole

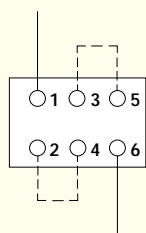

Double Pole

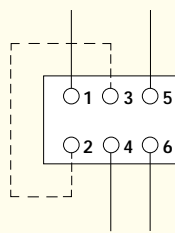



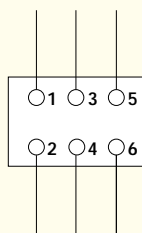



Triple Pole

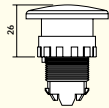
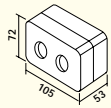

**SPECIFICATION R22 PUSH-BUTTON UNITS**

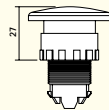
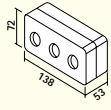
Conventional thermal current( <i>I<sub>th</sub></i> ) - open	12A						
- enclosed	10A						
Rated operating current (AC15)	V	120	240	380	480	500	600
	A	6	3	1.9	1.5	1.4	1.2
Rated operating current (DC15)	V	12	250	440	500	600	
	A	1.1	0.55	0.31	0.27	0.2	
Cable termination - min conductor size	1 x 0.5mm <sup>2</sup>						
- max conductor size	2 x 2.5 or 1 x 3.3mm <sup>2</sup>						
Back-up protection HRC fuse gG	10A						
Ambient temperature limits - operation	°C -20 to +55						
- storage	°C -30 to +70						
Standards (type tests)	IEC947-5-1, BS EN60947-5-1						

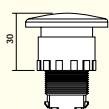
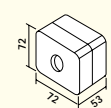
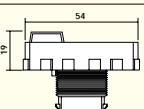
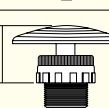
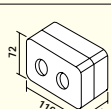
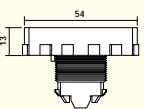
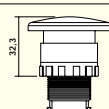
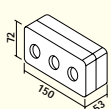
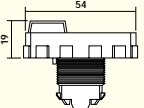
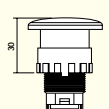
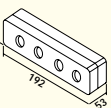
**DIMENSIONS**

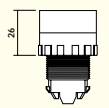
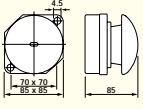
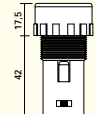
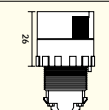
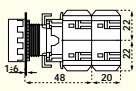
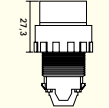
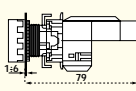
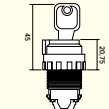
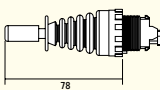
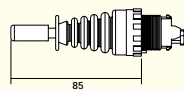
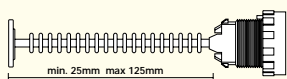
<p><b>22ER</b> <b>22MR</b></p> 	<p><b>22EF</b> <b>22MF</b></p> 	<p><b>22EV2</b></p> 
<p><b>22ERR</b> <b>22MRR</b></p> 	<p><b>22EFB</b> <b>22MFB</b> <b>22EFBL</b> <b>22MFBL</b></p> 	<p><b>22EV3</b></p> 
<p><b>22ER/PP</b> <b>22MR/PP</b> <b>22ERL/PP</b> <b>22MRL/PP</b></p> 	<p><b>22EFBC</b> <b>22MFBC</b></p> 	<p><b>22EV1</b> <b>22EVK1</b></p> 
<p><b>22EPD/0-1</b> <b>22EPDL/0-1</b></p> 	<p><b>22EFBA</b> <b>22MFBA</b></p> 	<p><b>22EVK2</b></p> 
<p><b>22EPD/F</b> <b>22EPDL/F</b></p> 	<p><b>22EFB/PP</b> <b>22MFB/PP</b> <b>22EFBL/PP</b> <b>22MFBL/PP</b></p> 	<p><b>22EVK3</b></p> 
<p><b>22EPDR/0-1</b> <b>22EPDLR/0-1</b></p> 	<p><b>22EFC</b> <b>22MFC</b></p> 	<p><b>22EVK4</b></p> 
<p><b>22EL</b> <b>22ML</b></p> 	<p><b>22ERL</b> <b>22MRL</b></p> 	<p><b>22EV90</b></p> 
<p><b>22ELE</b></p> 	<p><b>22ES</b> <b>22MS</b></p> 	
<p>With contact block fitted <b>22EC</b> <b>22ECD</b></p> 	<p><b>22ESL-L</b> <b>22MSL-L</b></p> 	
<p>With contact block fitted <b>22ECT</b> <b>22ECL</b></p> 	<p><b>22ESC</b> <b>22MSC</b></p> 	
<p><b>22EM</b> <b>22MM</b></p> 	<p><b>22EMB</b> <b>22MMB</b></p> 	
<p><b>22RESET</b> <b>22MRESET</b></p>  <p>min. 25mm max 125mm</p>		

## MCS SPECIFICATION DATA

RATING IN AMPS	16A	25A	32A	40A	63A	80A
Rated Insulation Voltage $U_i$ (V)	800	800	800	800	800	800
Dielectric Strength (kV) 50 Hz 1min	3	3	3	3	3	3
Shock Resistance $U_{imp}$ (kV)	8	8	8	8	8	8
<b>OPERATIONAL CURRENT <math>I_e</math> (A)</b>						
415 V AC - AC 21 A / AC 21 B	16	25	32	40	63	80
AC 22 A / AC 22 B	16	25	32	40	63	80
AC 23 A / AC 23 B	16	25	32	40	63	80
500 V AC - AC 21 A / AC 21 B	16	25	32	40	63	80
AC 22 A / AC 22 B	16	25	32	40	63	80
AC 23 A / AC 23 B	16	25	32	40	40	63
690 V AC - AC 20 A / AC 20 B	16	20	32	40	63	80
AC 21 A / AC 21 B	16	20	32	40	63	80
AC 22 A / AC 22 B	16	20	32	40	63	80
AC 23 A / AC 23 B	16	25	25	25	50	50
<b>MOTOR POWER (KW) AC 23</b>						
415 V AC	7.5	9	11	11	18.5	22
500 V AC	7.5	9	11	15	22	30
690 V AC	11	11	11	18.5	25	30
<b>OVERLOAD CAPACITY</b>						
Fuse rating gG	16	25	32	40	63	80
Short circuit current with fuses (kA Rms)	50	50	50	50	50	40
Asymmetric short time rating current (kA peak)	6	6	6	6	9	9
Admissible short time current 1 s. (kA Rms)	1.26	1.26	1.26	1.26	1.5	1.5
<b>MAKING &amp; BREAKING CHARACTERISTICS</b>						
Breaking capacity (A Rms)						
415 V AC 23 A	128	200	256	320	504	640
Making capacity (A Rms)						
415 V AC 23 A	160	250	320	400	630	800
<b>WITHSTAND</b>						
Mechanical (number of operations) x 1000	100	100	100	100	30	30
Electrical (number of operations at 415V AC 23A) x 1000	3	3	3	3	1.5	1.5
<b>CONNECTION</b>						
Maximum Cu cable section (mm <sup>2</sup> ) lth	16	16	16	16	50	50

## IP65 ENCLOSURES

BOX SIZE	A	B	C	D
A	130	85	75	105
B	175	125	100	137
C	250	175	100	135
D	310	200	135	170
0	154	85	114	152
1	212	124	117	156

## MCS DIMENSIONS

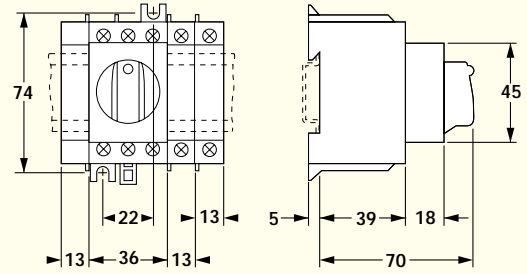

16A - 40A MCS

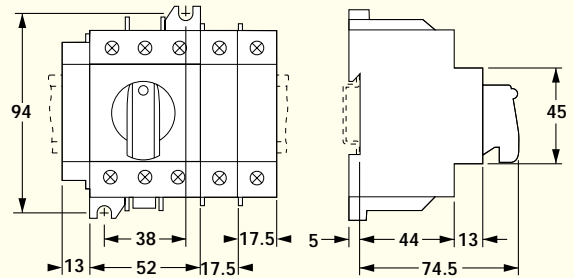

63A - 80A MCS

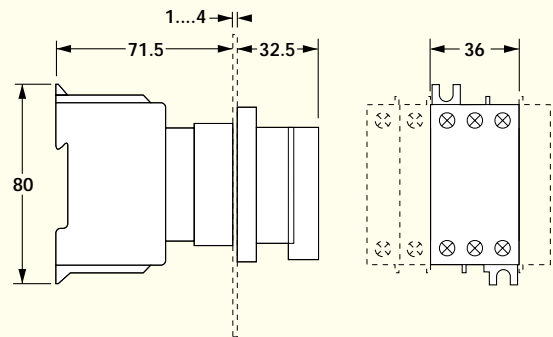

Door Mounting Details

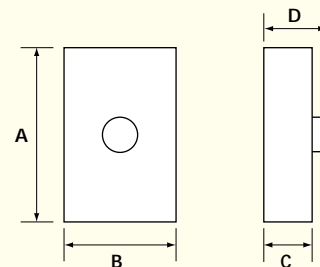

## FULL LOAD CURRENTS OF MOTORS (approx)

Please note that the kW and HP ratings given below and elsewhere in this publication are to be used only as a guide to the selection of the required starter. The actual full load current of the motor should be determined to ensure that a starter having a suitably rated overload relay is chosen.

RATING OF MOTOR		ALTERNATING CURRENT (A)					
kW	HP	Single phase	Three phase				
		240V	220V	380V	415V	440V	500V
0.06	0.08	1.2	0.38	0.22	0.21	0.19	0.16
0.09	0.12	1.5	0.56	0.33	0.30	0.28	0.24
0.12	0.16	1.8	0.76	0.42	0.39	0.37	0.33
0.18	0.25	2.8	1.1	0.58	0.52	0.49	0.46
0.25	0.33	3.2	1.4	0.88	0.71	0.64	0.59
0.37	0.50	3.5	2.1	1.3	1.2	1.1	0.85
0.55	0.75	4.8	2.7	1.5	1.4	1.3	1.2
0.75	1.0	6.2	3.3	2.1	2.0	1.7	1.5
1.1	1.5	8.7	4.9	2.6	2.5	2.3	2.1
1.5	2.0	11.8	6.2	3.6	3.5	3.1	2.6
2.2	3.0	17.5	8.7	5.1	5.0	4.4	3.8
3.0	4.0	20	11.6	6.6	6.5	5.8	5.1
3.7	5.0	24	14.2	8.2	7.5	7.1	6.2
4.0	5.5	29	15.3	8.5	7.7	7.6	6.5
5.5	7.5	36	21	11.5	11	10.3	8.9
7.5	10	45	27	15.5	14	13.5	11.9
11.0	15	70	39	22	21	19.3	16.7
15.0	20	91	53	30	29	27	23
18.5	25	113	64	37	35	32	28
20	27	128	70	40	38	35	31
22	30	135	75	43	40	38	33
25	34	156	85	50	45	42	38
30	40	180	101	60	54	51	44
37	50		124	72	66	62	54
40	54		134	79	77	67	60
45	60		150	85	80	74	65
55	75		181	105	98	90	79
59	80		194	112	105	97	85
75	100		245	140	135	123	106
90	125		292	170	165	146	128
100	134		325	188	179	162	143
110	150			205	200	178	156
129	175			242	230	209	184
132	180			245	236	214	186
147	200			273	259	236	207
160	220			295	278	256	220
184	250			340	325	295	259
200	270			370	350	321	278

List No	Page No	List No	Page No	List No	Page No	List No	Page No
1/MB	17	22ERL-PP4	19	22MR/PP5	19	15480	23
1/MBA	17	22ERL-PP5	19	22MR/PP6	19	15480/11	23
1/MBAK	17	22ERL-PP6	19	22MR1	19	19016	23
1/MBK	17	22ERL2	19	22MR2	19	19025	23
1/MBM	17	22ERL3	19	22MR3	19	19032	23
1/MBS	17	22ERL4	19	22MR4	19	19040	23
2/MB	17	22ERL5	19	22MR5	19	19063	23
2/MBA	17	22ERL6	19	22MR6	19	19080	23
2/MBM	17	22ERPD	21	22MRESET	19	19701	23
16/MS	23	22ERPDR	21	22MRL-PP2	19	19811	23
22EB	21	22ERPF	21	22MRL-PP3	19	19813	23
22EC/NC	21	22ERPL	21	22MRL-PP4	19	19821	23
22EC/NC-EV	21	22ERPR	21	22MRL-PP5	19	19823	23
22EC/NO	21	22ERR1	19	22MRL-PP6	19	19963	23
22EC/NO-EV	21	22ERR2	19	22MRL2	19	199125	23
22ECD	21	22ERR3	19	22MRL3	19	22054	21
22ECL/130	21	22ERR4	19	22MRL4	19	22635	21
22ECL/230	21	22ERR5	19	22MRL5	19	22636	21
22ECL/24	21	22ERR6	19	22MRL6	19	22637	21
22ECT/110	21	22ES1A	20	22MRR1	19	22638	21
22ECT/230	21	22ES1CD	20	22MRR2	19	22639	21
22ECT/400	21	22ES1CD/R	20	22MRR3	19	22640	21
22ED40	21	22ES1E	20	22MRR4	19	22641	21
22ED60	21	22ES1E/RC	20	22MRR5	19	22642	21
22ED90	21	22ES1E/RD	20	22MRR6	19	22643	21
22EF1	19	22ES1E/RS	20	22MS1A	20	22644	21
22EF2	19	22ESCA/J	20	22MS1CD	20	22645	21
22EF3	19	22ESCCD/J	20	22MS1CD/R	20	22646	21
22EFB/PP1	19	22ESCCD/R/	20	22MS1E	20	22648	21
22EFB/PP2	19	22ESCE/J	20	22MS1E/RC	20	22650	21
22EFB/PP3	19	22ESCE/RC/	20	22MS1E/RD	20	22651	21
22EFB2	19	22ESCE/RD/	20	22MS1E/RS	20	22652	21
22EFBA2	19	22ESCE/RS/	20	22MSCA/J	20	22654	21
22EFBC2	19	22ESL-L2A	20	22MSCCD/J	20	22931/AHCV	18
22EFBL-PP2	19	22ESL-L2CD	20	22MSCCD/R/	20	22931/AJV	18
22EFBL-PP3	19	22ESL-L2CD	20	22MSCE/J	20	22931/AKHC	18
22EFBL2	19	22ESL-L2E	20	22MSCE/RC/	20	22931/AKV	18
22EFC2	19	22ESL-L2E/	20	22MSCE/RD/	20	22931/AV	18
22EFL2	19	22ESL-L2E/	20	22MSCE/RS/	20	22931/GV	18
22EFL3	19	22ESL-L2E/	20	22MSL-L2A	20	22931/K2V	18
22EL2	19	22EV1	21	22MSL-L2CD	20	22931/MHCV	18
22EL3	19	22EV2	21	22MSL-L2CD	20	22931/MV	18
22EL4	19	22EV3	21	22MSL-L2E	20	22931/RV	18
22EL5	19	22EV90	17	22MSL-L2E/	20	22931/SK2V	18
22EL6	19	22EVG1	21	22MSL-L2E/	20	22932/AV	18
22ELE2	19	22EVK-1	21	22MSL-L2E/	20	22932/MV	18
22ELE3	19	22EVK-1/G	21	22RESET	19	22932/SV	18
22ELE4	19	22EVK-2	21	22T22	21	22932/UDV	18
22ELE5	19	22EVK-3	21	25/MS	23	22933/MFRV	18
22ELE6	19	22EVK-4	21	3/MB	17	22933/MPLV	18
22EM2F	20	22MF1	19	32/MS	23	22933/MUDV	18
22EM2R	20	22MF2	19	40/MS	23	22934/M2PL	18
22EM4F	20	22MF3	19	63/MS	23	40000/M2S	7
22EM4R	20	22MFB/PP1	19	80/MS	23	40000/M2X	7
22EMB2F	20	22MFB/PP2	19	220HC/K	21	40000/M4B	7
22EMB2R	20	22MFB/PP3	19	220Z	21	40000/M4C	7
22EMB4F	20	22MFB2	19	15040	25	40000/M4P	7
22EMB4R	20	22MFBA2	19	15042	25	40600/C2S	7
22EPD/F	21	22MFBC2	19	15044/1	25	40600/C2T	7
22EPD/O-I	21	22MFBL-PP2	19	15044/2	25	40600/C2X	7
22EPDL/F	21	22MFBL-PP3	19	15045	23	40600/C4A	7
22EPDL/O-I	21	22MFBL2	19	15045/1	25	40600/C4B	7
22EPDLR/O-	21	22MFC2	19	15045/2	25	40600/C4C	7
22EPDR/O-I	21	22MFL2	19	15045/3	25	40600/C4N	7
22EQ15	21	22MFL3	19	15045/5	25	40600/C4P	7
22EQ16	21	22ML2	19	15046	23	40600/XA	10
22EQ21	21	22ML3	19	15055	23	40600/XB	10
22EQ8	21	22ML4	19	15070	23	40600/XC	10
22ER/PP1	19	22ML5	19	15090	23	41400/YB	7
22ER/PP2	19	22ML6	19	15150	23	41400/YJ	7
22ER/PP3	19	22MM2F	20	15200	23	41400/YM	7
22ER/PP4	19	22MM2R	20	15300	23	41400/YP	7
22ER/PP5	19	22MM4F	20	15416	23	41400/ZB	7
22ER/PP6	19	22MM4R	20	15416/11	23	41400/ZJ	7
22ER1	19	22MMB2F	20	15425	23	41400/ZM	7
22ER2	19	22MMB2R	20	15425/11	23	41400/ZP	7
22ER3	19	22MMB4F	20	15432	23	41600/AB	7
22ER4	19	22MMB4R	20	15432/11	23	41600/AJ	7
22ER5	19	22MR/PP1	19	15440	23	41600/AM	7
22ER6	19	22MR/PP2	19	15440/11	23	41600/AP	7
22ERL-PP2	19	22MR/PP3	19	15463	23	41600/BB	7
22ERL-PP3	19	22MR/PP4	19	15463/11	23	41600/BJ	7

List No	Page No	List No	Page No	List No	Page No	List No	Page No
41600/BM	7	50000/A11	10	55400/YM	8	57011/AD1	5
41600/BP	7	50000/A13	10	55400/ZB	3,6,8	57011/AD2	5
41600/CB	7	50000/A22	10	55400/ZJ	3,8	57200/OB	4,8
41600/CJ	7	50000/A31	10	55400/ZM	3,8	57200/OJ	4,8
41600/CM	7	50000/B02	10	55500/BC	3,4,9	57200/OM	4,8
41600/CP	7	50000/B11	10	55500/CC	3,4,9	57300/OB	5,8
42000/4	7	50000/B13	10	55500/DC	3,4,9	57300/OJ	5,8
42400/YB	7	50000/B22	10	55500/FC	3,4,9	57300/OM	5,8
42400/YJ	7	50000/B31	10	55500/GC	3,4,9	57400/ZB	3,6,8
42400/YM	7	50000/C02	10	55500/HC	3,4,9	57400/ZJ	3,8
42400/YP	7	50000/C11	10	55500/JC	3,4,5,9	57400/ZM	3,8
42400/ZB	7	50000/C31	10	55500/KC	3,4,5,9	57500/BC	9
42400/ZJ	7	50000/D01	10	55500/MC	3,4,5,9	57500/CC	9
42400/ZM	7	50000/D10	10	55500/NC	3,4,5,9	57500/DC	9
42400/ZP	7	50000/E01	10	56000/2	11	57500/FC	9
42600/AB	7	50000/E10	10	56000/ZK	6	57500/GC	9
42600/AJ	7	50600/A02	10	56200/OB	4,8	57500/HC	9
42600/AM	7	50600/A03	10	56200/OJ	4,8	57500/JC	9
42600/AP	7	50600/A04	10	56200/OM	4,8	57500/KC	9
42600/BB	7	50600/A11	10	56300/OB	5,8	57500/MC	9
42600/BJ	7	50600/A12	10	56300/OJ	5,8	57500/NC	9
42600/BM	7	50600/A13	10	56300/OM	5,8	57500/PC	3,4,5,9
42600/BP	7	50600/A20	10	56400/ZB	3,8	57500/QC	3,4,5,9
42600/CB	7	50600/A21	10	56400/ZJ	3,8	CA110	13
42600/CJ	7	50600/A22	10	56400/ZM	3,8	CA230	13
42600/CM	7	50600/A30	10	56600/QB	11	CA24	13
42600/CP	7	50600/A31	10	56600/QC	11	CA400	13
48000/ZA	11	50600/A40	10	56600/QE	11	CA48	13
48200/OB	4,8	51500/DC	9	56600/QH	11	CHHSLA11	15
48200/OJ	4,8	51500/EC	9	56600/QJ	11	CHHSLA20	15
48200/OM	4,8	51500/FC	9	56600/QM	11	CIK22-02	15
48300/OB	5,8	51500/GC	9	56600/QN	11	CIK22-11	15
48300/OJ	5,8	51500/HC	9	57000/2	11	CIK22-20	15
48300/OM	5,8	51500/IC	9	57000/4	10	CIK24-04	15
48400/XB	3,6,8	51500/JC	9	57000/EA	11	CIK24-22	15
48400/XJ	3,8	51500/KC	9	57000/EA3	11	CIK24-31	15
48400/XM	3,8	51500/LC	9	57000/EB	11	CIK24-40	15
49000/2	11	51500/MC	9	57000/EB3	11	CIK40-04	15
49000/4	10	51500/NC	9	57000/EE	11	CIK40-22	15
49000/EA	11	53200/OB	4,8	57000/EE3	11	CIK40-31	15
49000/EB	11	53200/OJ	4,8	57000/EF	11	CIK40-40	15
49000/EG	11	53200/OM	4,8	57000/EF3	11	CIK63-04	15
49000/EH	11	53200/OP	4	57000/EG	11	CIK63-22	15
49000/EJ	11	53400/YB	8	57000/EG3	11	CIK63-31	15
49000/EK	11	53400/YJ	8	57000/EH	11	CIK63-40	15
49000/EM	11	53400/YM	8	57000/EH3	11	CM	13
49000/EN	11	53400/ZB	3,8	57000/EJ	11	CMS25-0.16	13
49000/EP	11	53400/ZJ	3,8	57000/EJ3	11	CMS25-0.25	13
49000/EQ	11	53400/ZM	3,8	57000/EK	11	CMS25-0.4	13
49000/ER	11	53400/ZP	3	57000/EK3	11	CMS25-0.63	13
49000/ZA	11	53600/AB	10	57000/EL	11	CMS25-1	13
49000/ZK	6	53600/AJ	10	57000/EL3	11	CMS25-1.6	13
49001/AA0	3	53600/AM	10	57000/EM	11	CMS25-10	13
49001/AA1	3,6	53600/BB	10	57000/EM3	11	CMS25-16	13
49001/AA2	3	53600/BJ	10	57000/EN	11	CMS25-2.5	13
49001/AB0	4	53600/BM	10	57000/EN3	11	CMS25-20	13
49001/AC0	5	53600/CB	10	57000/EP	11	CMS25-25	13
49001/AC1	4,5,6	53600/CJ	10	57000/EP3	11	CMS25-4	13
49001/AC2	4,5	53600/CM	10	57000/EQ	11	CMS25-6.3	13
49011/AC0	3	54200/OB	4,8	57000/EQ3	11	CNAT	13
49011/AC1	3,6	54200/OJ	4,8	57000/ER	11	CNL	13
49011/AC2	3	54200/OM	4,8	57000/ER3	11	CO-55	13
49011/AD0	4	54400/YB	8	57000/ET	11	CPS01	13
49011/AE0	5	54400/YJ	8	57000/ET3	11	CPS10	13
49011/AE1	4,5,6	54400/YM	8	57000/EX	11	CPS11	13
49011/AE2	4,5	54400/ZB	3,8	57000/EX3	11	CPS20	13
49200/OB	4,8	54400/ZJ	3,8	57001/AA0	3	CSSR230	13
49200/OJ	4,8	54400/ZM	3,8	57001/AA1	3,6	CU110	13
49200/OM	4,8	55001/AA0	3	57001/AA2	3	CU230	13
49300/OB	5,8	55001/AB0	4	57001/AB0	4	CU24	13
49300/OJ	5,8	55001/AC0	5	57001/AB1	4,6	CU400	13
49300/OM	5,8	55011/AA0	3	57001/AB2	4	CU48	13
49400/XB	3,6,8	55011/AC0	4	57001/AC0	5	CZ	13
49400/XJ	3,8	55011/AD0	5	57001/AC1	5		
49400/XM	3,8	55200/OB	4,8	57001/AC2	5		
49500/AD	3,4,5,9	55200/OJ	4,8	57011/AA0	3		
49500/BD	3,4,5,9	55200/OM	4,8	57011/AA1	3,6		
49500/CD	3,4,5,9	55300/OB	5,8	57011/AA2	3		
49500/DD	3,4,5,9	55300/OJ	5,8	57011/AC0	4		
49500/ED	3,4,5,9	55300/OM	5,8	57011/AC1	4,6		
49500/FD	3,4,5,9	55400/YB	8	57011/AC2	4		
50000/A02	10	55400/YJ	8	57011/AD0	5		

# TERMS & CONDITIONS OF SALE OF GOODS

## HOME

### 1 Contract Terms Quotations & Orders

- 1.1 Unless other terms and conditions are expressly accepted by Electrium Sales Ltd. by means of a specific written amendment hereto signed by Electrium Sales Ltd. or a Director of Electrium Sales Ltd. the contract will be on the terms and conditions set out below ("the Contract Terms") to the exclusion of any other terms and conditions (except those implied in favour of a seller which are not inconsistent with the Contract Terms) whether or not the same are endorsed upon, delivered with or referred to in any purchase order or other document delivered or sent by the Customer to Electrium Sales Ltd. or by Electrium Sales Ltd. to the Buyer reference made by Electrium Sales Ltd. to the Customer's order, specification or like document will not be deemed to imply that any terms or conditions endorsed upon, delivered with or referred to in such order, specification or like document will have effect to the exclusion or amendment of the Contract Terms. No variation, addition or modification of the Contract Terms, conditions shall be binding on Electrium Sales Ltd. unless such variation, addition or modification be agreed to in writing under the signature of a Director of Electrium Sales Ltd.
- 1.2 Any quotation is given on the basis that no contract will come into existence until the Customer places an order pursuant thereto. Any quotation is valid for a period of 30 days only from its date provided that Electrium Sales Ltd. has not previously withdrawn it.

### 2 Price

The price of Goods supplied hereunder ("the Goods") is exclusive of VAT or any successor tax thereto unless otherwise agreed in writing. The price for the Goods shall be (unless otherwise agreed by Electrium Sales Ltd. in writing) the list price of Electrium Sales Ltd. current at the date of despatch and in the case of an order for delivery by instalments the price payable for each instalment shall be Electrium Sales Ltd's list price current at the date of despatch for each instalment. All prices are based on standard pack sizes and quantities and Electrium Sales Ltd. reserves the right to levy an additional charge if such packs must be broken up to fulfil an order. The price of Goods is inclusive of costs of carriage to the Customer's premises in Great Britain and Northern Ireland except on individual orders having a net value calculated by reference to the Company's most recent price list of less than £200 (excluding VAT) which shall be subject to an additional charge of £15.00 (excluding VAT) to cover carriage and packing. The price of Goods is based on the costs of materials, labour, sub-contracts, transport, taxes, duties and currency exchange rates ruling at the date of the quotation. Electrium Sales Ltd. reserves the right to amend the contract price to take account of any variations in these costs or the imposition of any new taxes or duties occurring from whatever cause before delivery of the Goods.

### 3 Payment

The due date for payment shall be the last day of the month following the month of despatch of Goods supplied by Electrium Sales Ltd. Payment made before the due date for payment shall be subject to a settlement discount of 2.5%. VAT is calculated on the discounted value of the invoice and is not subject to settlement discount. Interest at an annual rate of 3% per month will accrue daily and be calculated on a daily basis on overdue accounts from the date of invoice until payment. Notwithstanding any Contract Term allowing the Customer credit payment shall become due and payable to Electrium Sales Ltd. immediately upon the termination of the contract. The Customer shall not be entitled to exercise any right of set-off or lien or any similar right or claim in connection with the Goods or the price payable therefor.

### 4 Packing Materials

Packing cases and cartons will be provided free of charge by Electrium Sales Ltd. All pallets used shall remain at all times the property of Electrium Sales Ltd. and are to be returned to Electrium Sales Ltd. on demand in good condition. Electrium Sales Ltd. reserves the right to alter the method of packing without reference to the Customer.

### 5 Damage or Loss in Transit

Electrium Sales Ltd. will not be liable in respect of any damage or discrepancy, shortage or loss in transit or any claim that the Goods delivered do not otherwise comply with the contract unless the Customer shall have informed the Company in writing, telex or facsimile as follows:

- Within three days of delivery in the event of any damage, discrepancy or shortage.
  - Within seven days of delivery in the event that the Goods do not comply with the contract, and
  - Within twenty-one days of receipt of the Company's invoice in the event of non-delivery.
- Where the Goods are accepted from the Company's carriers they shall be deemed to have been checked by the Purchaser and accepted unless the delivery receipt is signed and endorsed "unexamined" and the packing and its contents are retained for later inspection.

### 6 Delivery

The place of delivery for Goods shall be the Customer's premises or as otherwise agreed by Electrium Sales Ltd. in writing. The time of delivery will be as agreed between the parties or if no such agreement has been reached will be within a reasonable time and the Company will be entitled to make delivery by instalments. Where the customer requires delivery next day a charge of £13.50 will be made. In no circumstances will Electrium Sales Ltd. be liable for loss or damage of any kind whatsoever caused directly or indirectly by any delay in the delivery of Goods, nor unless such delay exceeds 180 days will any delay entitle the Customer to terminate or rescind the contract. Notwithstanding any other Contract Term, risk in the Goods shall pass to the Buyer when the Goods are delivered to the Customer or its agent.

### 7 Title of Goods

- Until Electrium Sales Ltd. has been paid in full for the Goods comprised in this and/or any other contract between the Customer and Electrium Sales Ltd., the Customer shall hold the Goods in a fiduciary capacity as bailee for Electrium Sales Ltd. and:
- the title to, ownership of, and the property in, the Goods shall remain vested in Electrium Sales Ltd. (notwithstanding delivery of the same and parting of the risk therein to the Customer) until payment in full for all Goods comprised in this and every other contract between Electrium Sales Ltd. and the Customer has been received by Electrium Sales Ltd.
  - The Customer shall be in possession of the Goods as Electrium Sales Ltd's bailee. If so required the Customer shall store the Goods for Electrium Sales Ltd. without charge to Electrium Sales Ltd. separate from any goods which are the property of the Customer and/or any third party and ensure that they are clearly marked and identified as belonging to Electrium Sales Ltd.
  - Electrium Sales Ltd. reserves the right to require the Customer to return the Goods and may recover and sell the same at any time. For that purpose Electrium Sales Ltd's servants and agents together with all necessary and appropriate transport shall be entitled to unrestricted access to the Customer's premises and any other location where the Goods are situated to take possession of the Goods and, if necessary, dismantle the Goods from any article or articles to which they may have been attached and to remove the Goods from the Customer's premises.
  - Prior to the property in the Goods passing to the Customer Electrium Sales Ltd. permits the Customer to deliver the Goods to a third party pursuant to a bona fide and arms-length agreement to re-sell the Goods and allows the Customer to convert or incorporate the Goods into or mix the Goods with other goods but such liberty will cease upon the termination of the contract.
  - Where Electrium Sales Ltd. is unable to determine whether any goods are Electrium Sales Ltd's Goods the Customer shall be deemed to have sold all goods of the kind sold by Electrium Sales Ltd. to the Customer in the order in which they were invoiced to the Customer.

### 8 Descriptive Matter

Descriptive matter, illustrations, dimensions and weights issued by Electrium Sales Ltd. are to be regarded as being for guidance only and cannot be held as binding in any way. In pursuance of Electrium Sales Ltd's policy of product improvement Electrium Sales Ltd. reserves the right to alter patterns and designs without prior notice.

### 9 Guarantee

Electrium Sales Ltd. will make good by replacement (or its option by repair) defects which under proper use appear in the Goods within a period of twelve calendar months after the Goods have been despatched, and which arise solely from faulty design, materials or workmanship provided always that defective Goods have been returned to Electrium Sales Ltd. and Electrium Sales Ltd. was notified of the defect or suspected defect immediately the same became known to the Customer. The cost of carriage on such returned Goods and the cost of re-delivery of the repaired or new Goods to be borne by Electrium Sales Ltd. Save for the Electrium Sales Ltd's control equipment which has been correctly repaired or modified by the use of standard parts supplied by Electrium Sales Ltd. for such purpose, Electrium Sales Ltd. excludes all liability in respect of any Goods which have been re-finished and dismantled or altered in any way or if the Goods were improperly installed or connected or if the Customer fails to observe or perform the requirements of any maintenance procedures relating to the Goods. Any Goods replaced will conform to Electrium Sales Ltd. Any repaired or replacement Goods will be guaranteed on these terms for the unexpired portion of the twelve month period. In addition, the obligations of Electrium Sales Ltd. under this condition will not apply if the Customer is in breach of this or any other contract with Electrium Sales Ltd. Subject to this condition, all conditions, warranties and representations, whether express or implied (by statute or otherwise) relating to the Goods are hereby excluded insofar as the same can be excluded without such exclusion being void or unenforceable. Electrium Sales Ltd. will be under no liability under the contract for any personal injury, death, loss or damage of any kind whatsoever (other than death or personal injury resulting from Electrium Sales Ltd's negligence) whether consequential or otherwise including but not limited to loss of profits and Electrium Sales Ltd. hereby excludes all conditions, warranties and stipulations express or implied, statutory, customary or otherwise which but for such exclusion would or might subsist in favour of the

Customer except that such exclusion will not apply to any implied condition that Electrium Sales Ltd. has or will have the right to sell the Goods when the property is to pass; or when Electrium Sales Ltd. deals as a consumer (as defined in section 12 of the Unfair Contract Terms Act 1977), any implied term relating to the conformity of the Goods with their description or sample or as to their quality or fitness for a particular purpose. In no circumstances will Electrium Sales Ltd. or its employees, agents or sub-contractors be liable for any loss or damage of any kind whatsoever (other than death or personal injury resulting from Electrium Sales Ltd's negligence) whether consequential or otherwise caused directly or indirectly by any negligence or other tortious act or breach of statutory duty on the part of Electrium Sales Ltd. or on the part of any of its employees, agents or sub-contractors in connection with or arising out of the manufacture or supply of the Goods or in connection with any statement given or made (or advice not given or made) by or on behalf of Electrium Sales Ltd.

### 10 Patents

Electrium Sales Ltd. will indemnify the Customer against any claim of infringement of letters patent, registered design, trademark or copyright (existing at the date of the contract) arising from the use or sale of any article or materials supplied by Electrium Sales Ltd. to the Customer and against all costs and damages which the Customer may incur in any action for such infringement or for which the Customer may become liable in any such action provided always that this indemnity shall not apply to any infringement which arises in connection with any design or instruction issued or given by the Customer to Electrium Sales Ltd. or to the use of such article or material in a manner or for a purpose outside the UK or to any infringement which is due to the use of such article or material in association or combination with any other article or material not supplied by Electrium Sales Ltd. and provided also that this indemnity is conditional on the Customer making no admission in respect of such alleged infringement and giving Electrium Sales Ltd. the earliest possible notice in writing of any claim being made or action threatened or brought against the Customer and on the Customer permitting Electrium Sales Ltd. at Electrium Sales Ltd's expense to conduct any litigation that may ensue and all negotiations for the settlement of a claim.

The Customer warrants that any design or instruction issued or given by the Customer shall not be such as will cause Electrium Sales Ltd. to infringe any letters patent, registered design, trademark or copyright in the execution of the Customer's order and the Customer agrees to indemnify and keep Electrium Sales Ltd. indemnified against all liability in the event that such warrant is found to be untrue, misleading or breached.

### 11 Advice

Advice which Electrium Sales Ltd. or its agents may give to the Customer shall be given in good faith but Electrium Sales Ltd. shall not be liable for any loss or damage arising directly or indirectly therefrom or attributable thereto unless contained in any written representation or statement issued directly by Electrium Sales Ltd.

### 12 Safety

The Customer shall ensure that any modifications whatsoever made to the Goods supplied hereunder comply with the requirements of any applicable Safety Regulations. Plugs supplied hereunder shall be so connected as to ensure that they are safe and in full compliance with any applicable Safety Regulations. The Customer shall ensure that any kits supplied hereunder are so assembled as to ensure that the assembled product is safe and complies with the requirements of any applicable Safety Regulations. Without prejudice to the above provisions, where Electrium Sales Ltd. provides the Customer with information about the use for which Goods are designed and have been tested and about any conditions to ensure that when put to that use they would be safe and without risk to health, the Customer shall use the Goods accordingly and comply with the said conditions. To be properly used the Goods shall be selected, installed, commissioned and maintained in accordance with good engineering practice and under the supervision of suitably qualified personnel.

### 13 Statutory and other Regulations

If the cost to Electrium Sales Ltd. of performing its obligations under any contract shall be increased or reduced by reason of making or amendment after the date of its quotation of any law or of any other order, regulation or bye-law having the force of law that shall affect the performance of Electrium Sales Ltd's contractual obligations, the amount of such increase or reduction shall be added to or deducted from the contract price as the case may be.

### 14 Cancellation

If the Customer cancels, extends or delays or purports to cancel, extend or delay the contract or part thereof, or fails to take delivery of any Goods at the time agreed (if any) or if no time is agreed within a reasonable time, then the Customer will be liable (without prejudice to any other rights of Electrium Sales Ltd. to claim damages) to indemnify and keep indemnified Electrium Sales Ltd. against any resulting loss, damage or expense incurred by Electrium Sales Ltd. in connection with the supply or non-supply of the Goods including the cost of any material, used or intended to be used therefor and the cost of labour and other overheads including a percentage in respect of profit. If Electrium Sales Ltd. is unable (whether temporarily or permanently) to procure any services or goods necessary to enable it to supply the Goods or if the supply of the Goods is prevented or hindered by reason of any cause beyond Electrium Sales Ltd's reasonable control which for the avoidance of doubt and without prejudice to the generality of the foregoing shall include governmental action, war, riot, civil commotion, fire, flood, epidemic, labour disputes including labour disputes involving the work force or any part thereof of Electrium Sales Ltd, restraints or delays affecting shipping or carriers, currency restrictions and Act of God, Electrium Sales Ltd. may cancel the contract by notice in writing to the Customer so far as it relates to Goods not then supplied or work not then done and such cancellation shall not give rise to any claims by the Customer provided that the Customer shall remain liable to pay for Goods delivered prior to the date of such cancellation.

### 15 General

- The headings herein are inserted for convenience only and shall not affect the interpretation of the Contract Terms.
- Should any clause contained in the Contract Terms be held to be invalid such invalidity will not affect the validity of the remaining clauses.
- Any dispute arising out of this contract or the Contract Terms shall be referred in writing to an independent arbitrator who shall be appointed by agreement between Electrium Sales Ltd. and the Customer or in default of agreement by the President for the time being of the Institute of Electrical Engineers whose decision shall be binding on both parties.
- The formation, interpretation and operation of the contract will be subject to English Law and the Customer submits himself to the non-exclusive jurisdiction of the English Courts.
- Electrium Sales Ltd. will be entitled to assign sub-contract or sub-let the contract or any part thereof.
- Failure by Electrium Sales Ltd. to enforce any of the Contract Terms will not be construed as a waiver of any of its rights hereunder.

## EXPORT

All Contract Terms set out above apply to overseas transactions (ie sales outside the United Kingdom), where appropriate, except the following:

- 1.2 Any quotation is given on the basis that no contract will come into existence until Electrium Sales Ltd. despatches an acknowledgement of order to the Customer. Any quotation is valid for a period of 30 days only from its date provided that Electrium Sales Ltd. has not previously withdrawn it.

### 2 Price

The price of Goods includes the cost of packing for shipment FOB British Port or Airport except that orders having a net value of £500 and below shall be subject to an additional charge to cover packing and carriage. No allowance will be made in lieu of transportation if the Customer accepts delivery at the factory, container depot or at any other inland destination or provides his own transportation or where packing of a lesser standard is required.

### 3 Payment

First orders from overseas Customers should be accompanied by bank references to enable payment terms to be agreed. Unless otherwise agreed in writing, payment is due on delivery. Goods shall be deemed to have been delivered when the invoice has been presented in the United Kingdom accompanied by the appropriate documents of title.

### 16 Others

The Goods will be sold FOB British Port or Airport and the Seller will be under no obligation to give the Buyer notice as specified in Section 32(3) of the Sale of Goods Act 1979. CIF or C & F arrangements can be made if requested by the Customer, at cost, and Electrium Sales Ltd. will, on receipt of Customer's indemnity, take all reasonable steps to recover from the Underwriters any loss or damage for which they may be liable. The Customer shall be solely responsible for complying with all legislation and regulations governing the importation of the Goods into the country of destination including import and export licences and the payment of duties thereon including but not limited to customs duties and VAT. The Customer shall indemnify Electrium Sales Ltd. against all costs claims and demands arising out of any breach by the Customer of this Agreement.

### CONDITIONS OF USE

The products listed in this publication should be installed by suitably qualified personnel in accordance with the requirements of relevant legislation, regulations (including the IEE Wiring Regulations) and the accepted practice in the industry. Any further information which may be required about the use for which any specific product has been designed and tested, or about conditions of use, is available on request. In pursuance of our policy of continuing product improvement, equipment described in this publication is subject to change without notification.



## Electrium

ELECTRIUM SALES LIMITED  
Lichfield Road Brownhills West Midlands  
WS8 6JZ England.  
eMail: [info@electrium.co.uk](mailto:info@electrium.co.uk)  
Web: [www.electrium.co.uk](http://www.electrium.co.uk)

UK SALES  
Telephone: 01543 455010  
Facsimile: 01543 455011  
eMail: [crabtree.sales@electrium.co.uk](mailto:crabtree.sales@electrium.co.uk)

EXPORT SALES  
Telephone: +44 1543 455049  
Facsimile: +44 1543 455048  
eMail: [export@electrium.co.uk](mailto:export@electrium.co.uk)

DUBAI OFFICE  
Telephone: +971 4 2666403  
Facsimile: +971 4 2668031

DUBLIN OFFICE  
Telephone: +353 1 8208047  
Facsimile: +353 1 8208107

SINGAPORE OFFICE  
Telephone: +65 2544905  
Facsimile: +65 2546570

Although every effort has been made to ensure accuracy in the compilation of the technical detail within this publication, specifications and performance data are constantly changing. Latest details can be obtained from Crabtree.

Publication No. C1963 05/01  
Printed in England.